

FILM1\_TOP, SIGNAL\_1

Mircea Bogdan  
The University of Chicago  
20-BIT ADC Tester Module  
#2881 - 8/10/2016

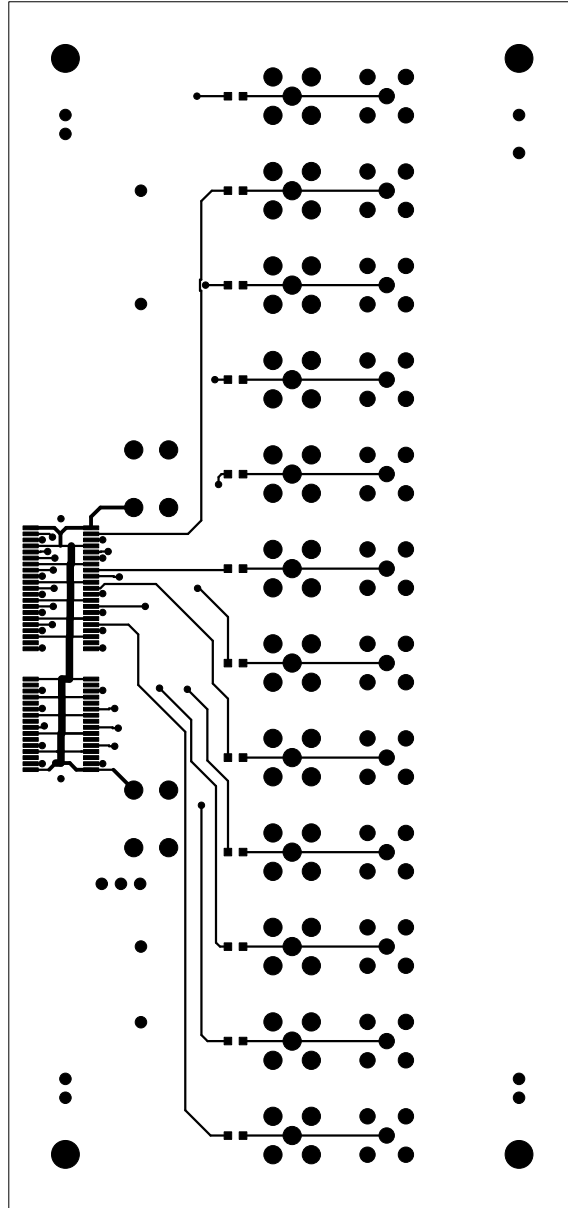

FILM2-GROUND

Mircea Bogdan  
The University of Chicago  
20-BIT ADC Tester Module  
#2881 - 8/10/2016

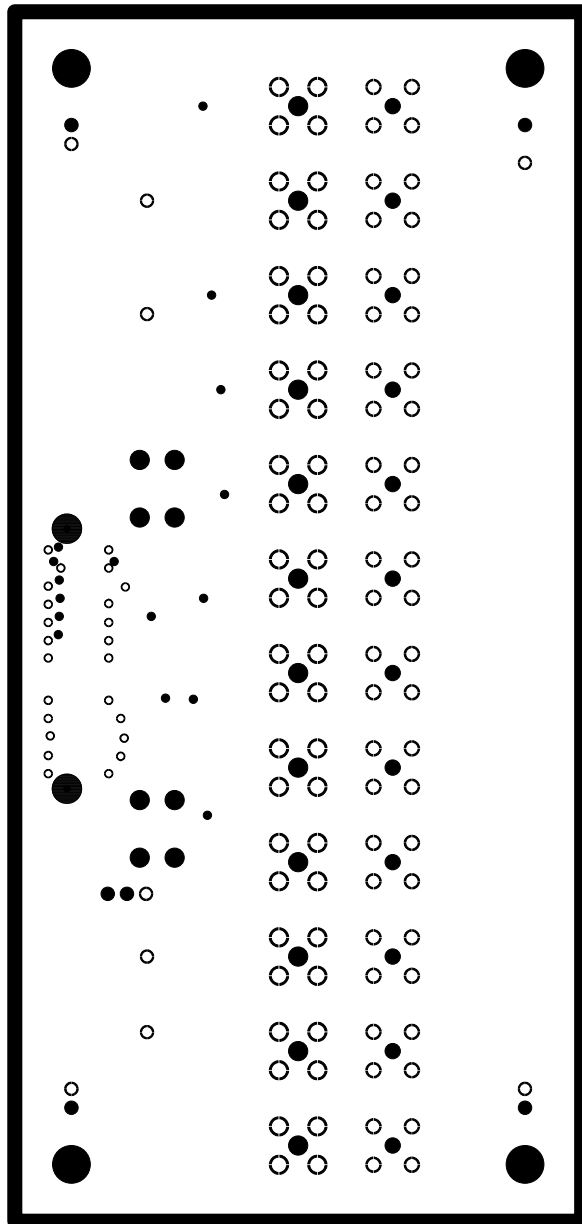

FILM3-GROUND

Mircea Bogdan  
The University of Chicago  
20-BIT ADC Tester Module  
#2881 - 8/10/2016

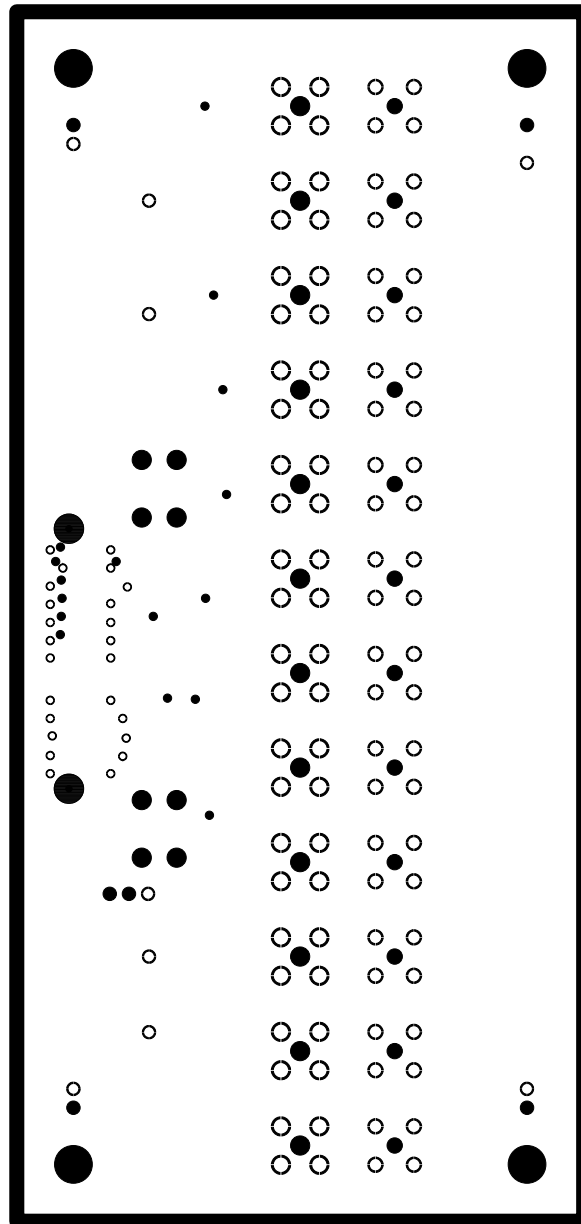

Mircea Bogdan  
The University of Chicago  
20-BIT ADC Tester Module  
#2881 - 8/10/2016

FILM4-Bottom, SIGNAL\_2

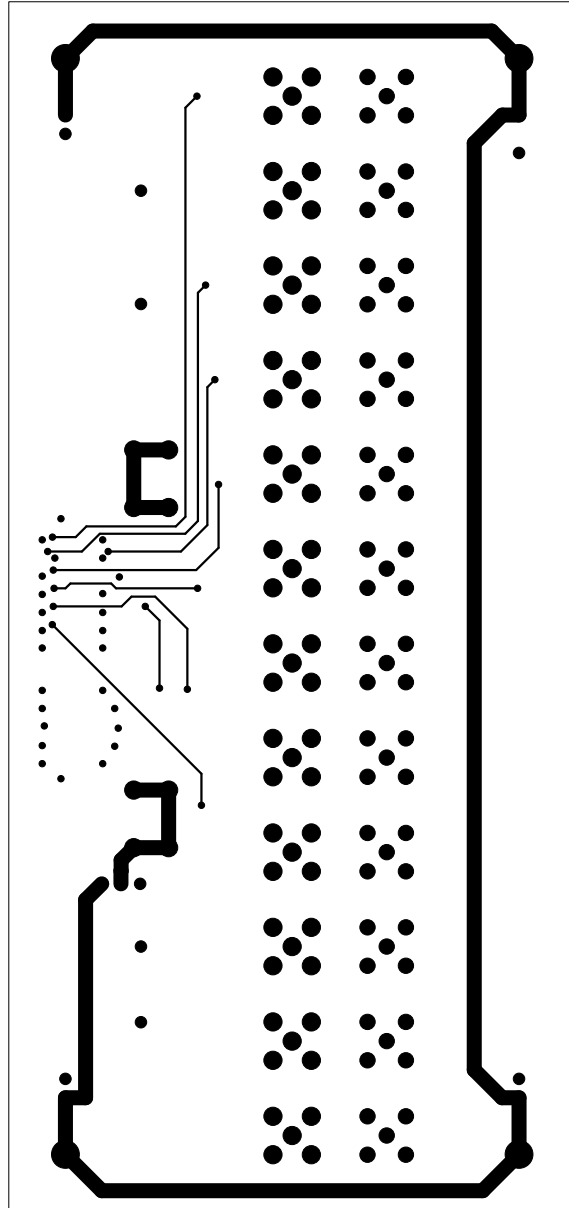



BOT SILK FILM6 Mircea Bogdan  
The University of Chicago  
20-BIT ADC Tester Module  
#2881 - 8/10/2016

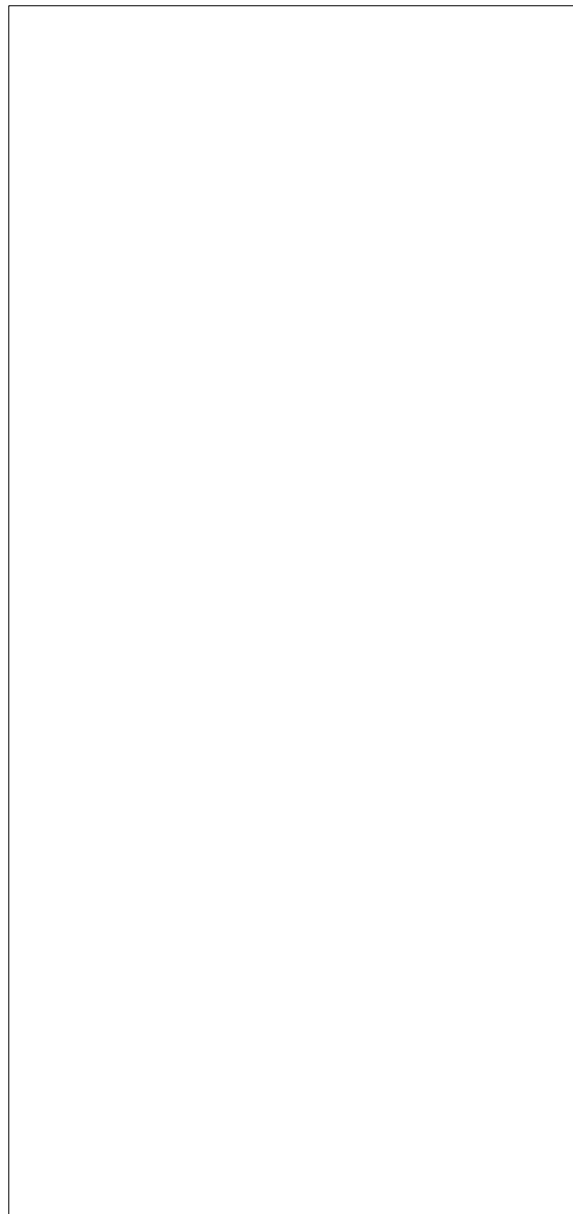

TOP MASK FILM7  
Mircea Bogdan  
The University of Chicago  
20-BIT ADC Tester Module  
#2881 - 8/10/2016

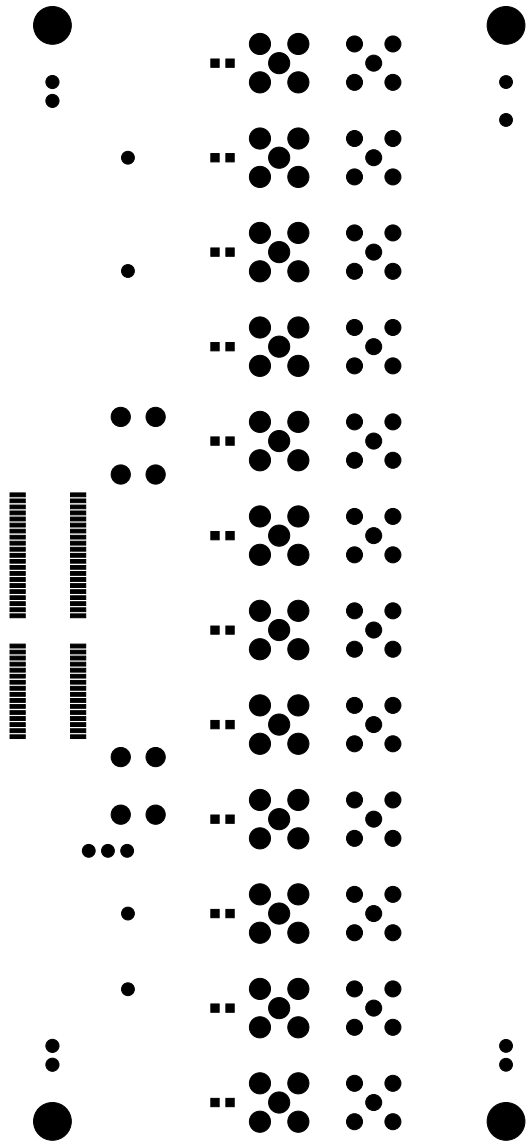

BOT MASK FILM8  
Mircea Bogdan  
The University of Chicago  
20-BIT ADC Tester Module  
#2881 - 8/10/2016

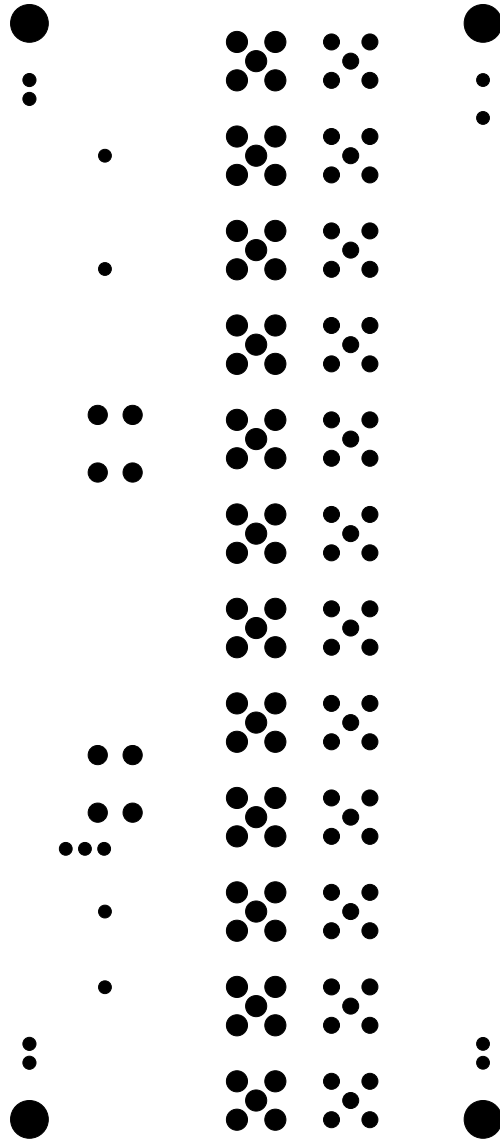



Mircea Bogdan  
The University of Chicago

TOP PASTE FILM9  
20-BIT ADC Tester Module  
#2881 - 8/10/2016

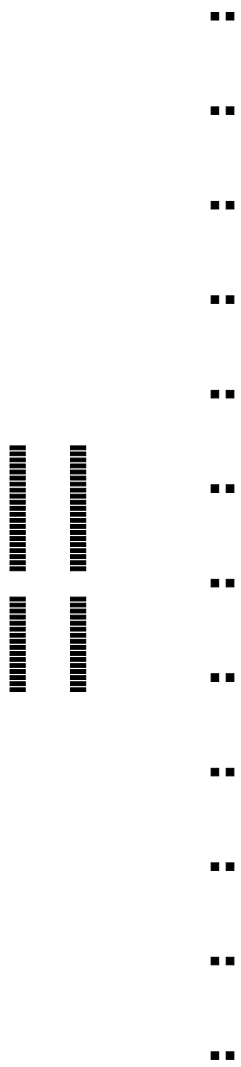

Mircea Bogdan  
The University of Chicago

20-BIT ADC Tester Module  
#2881 - 8/10/2016

BOT PASTE FILM10