

A

B

C

D

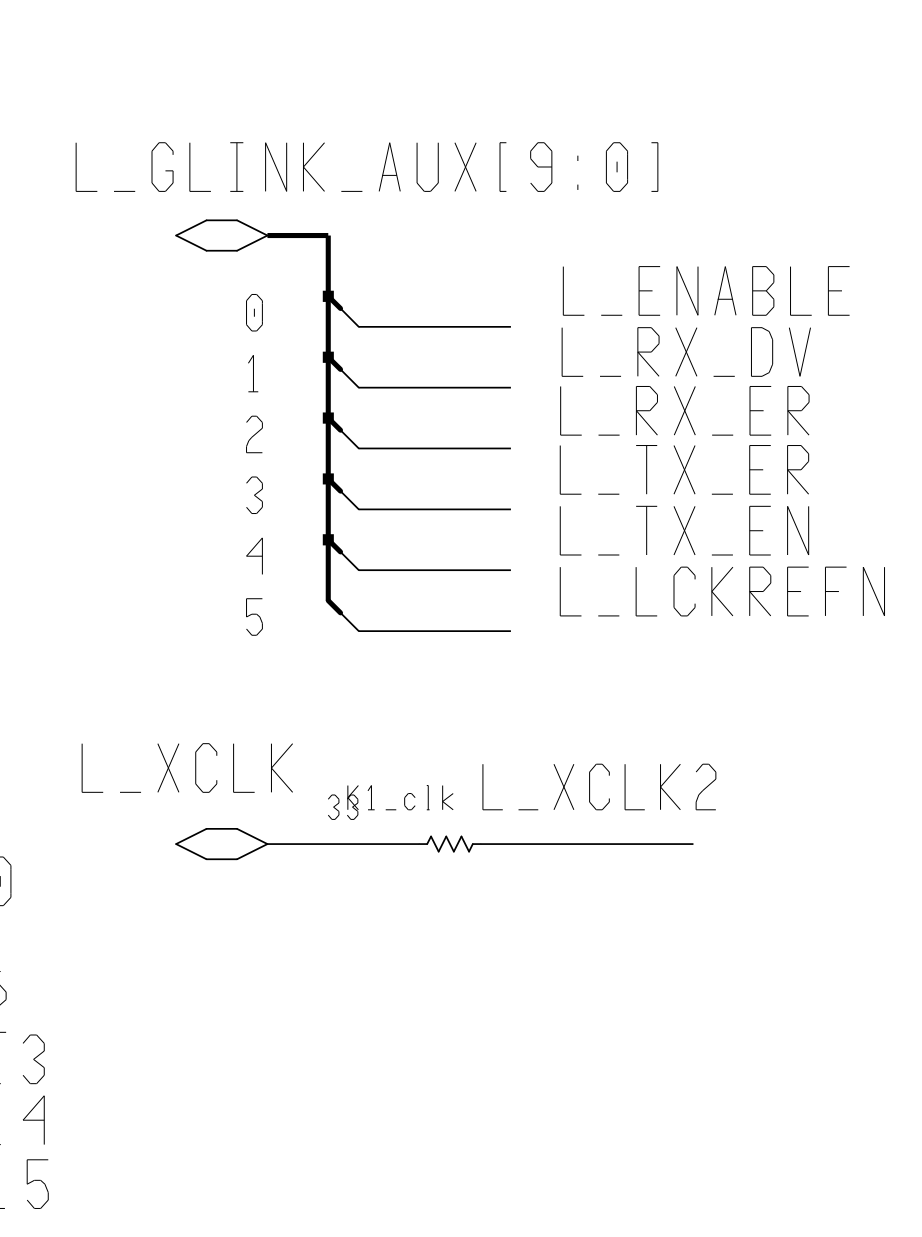
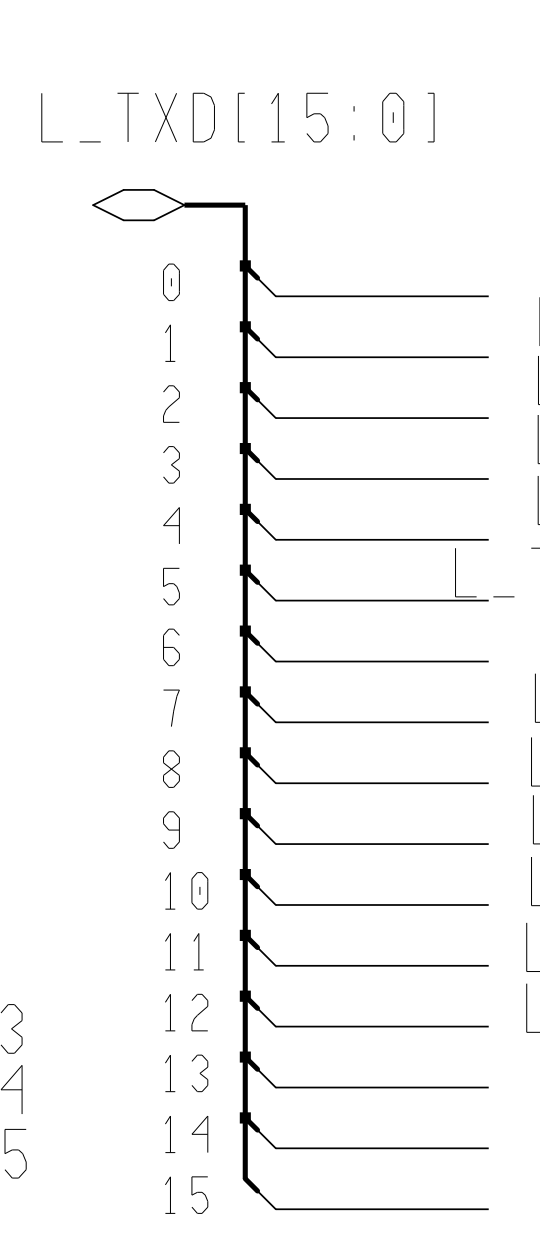
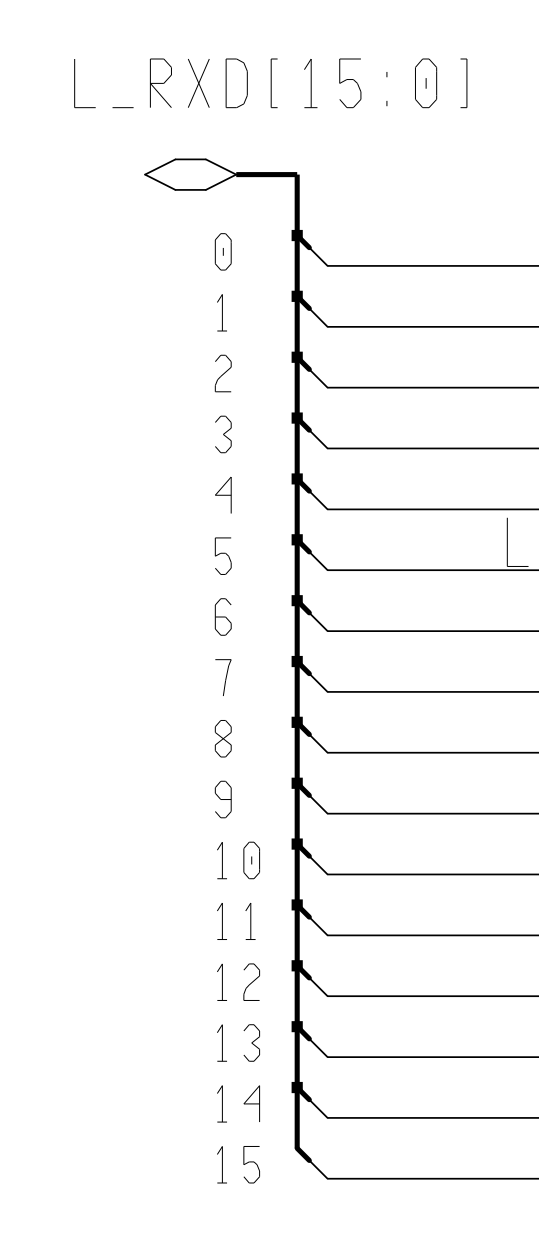
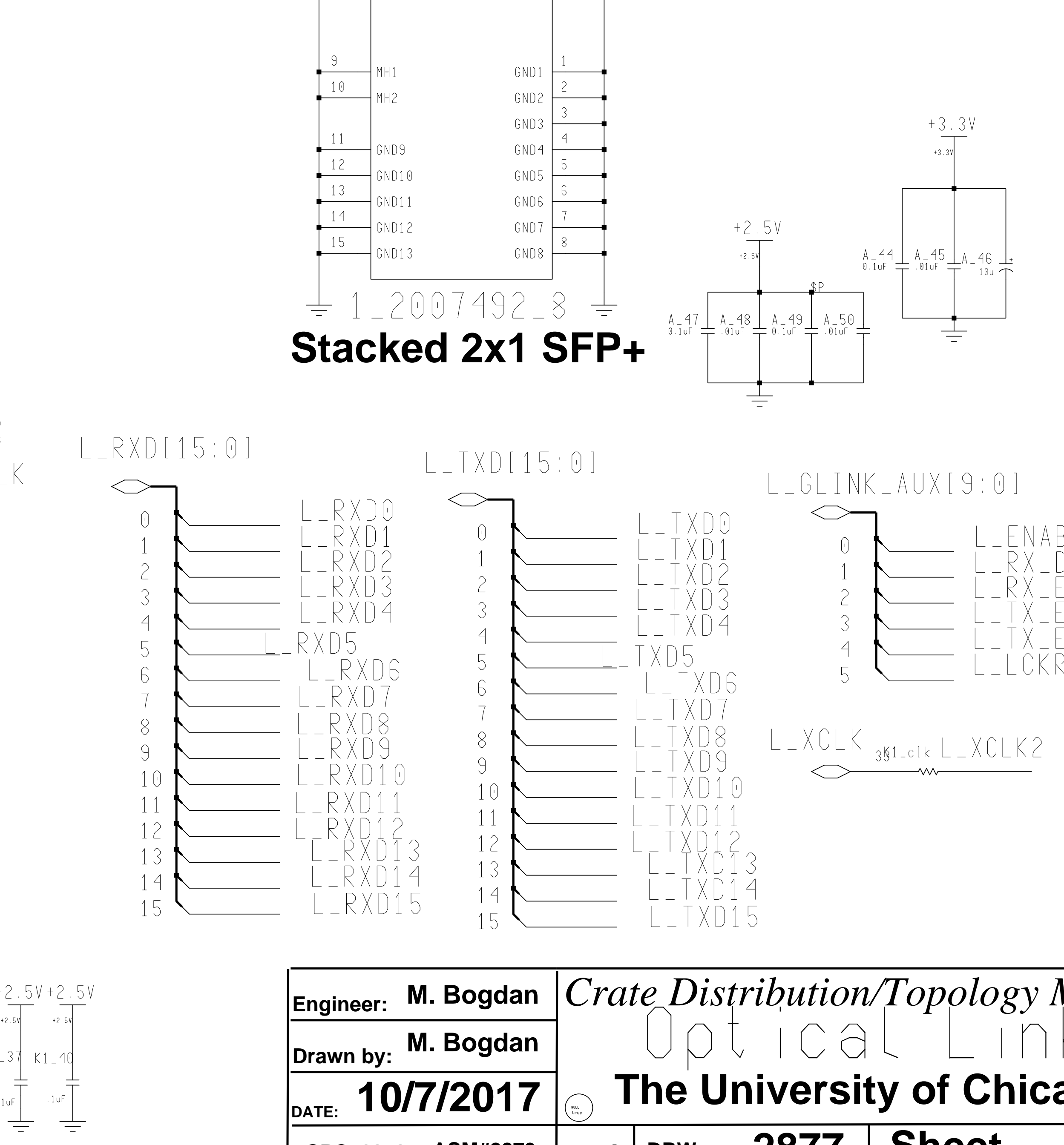
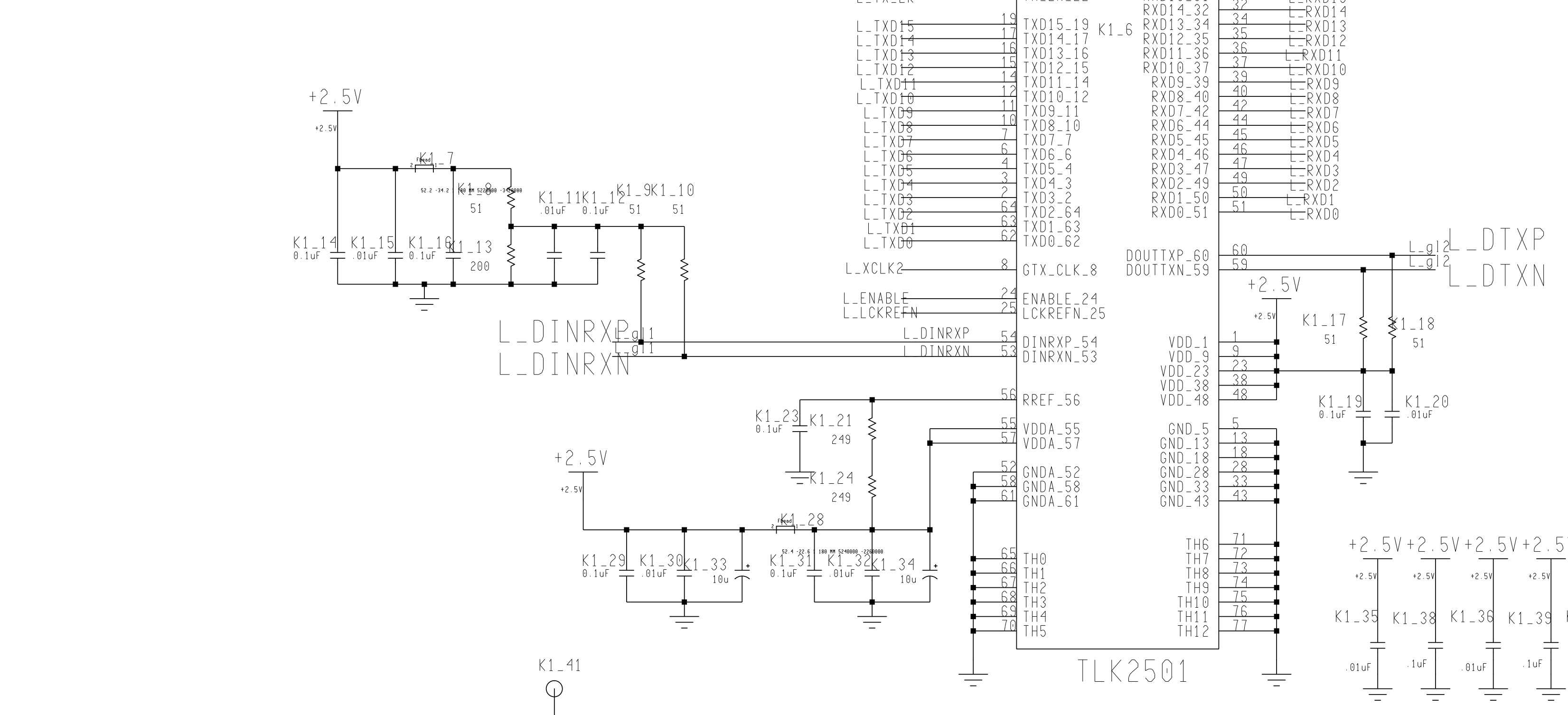
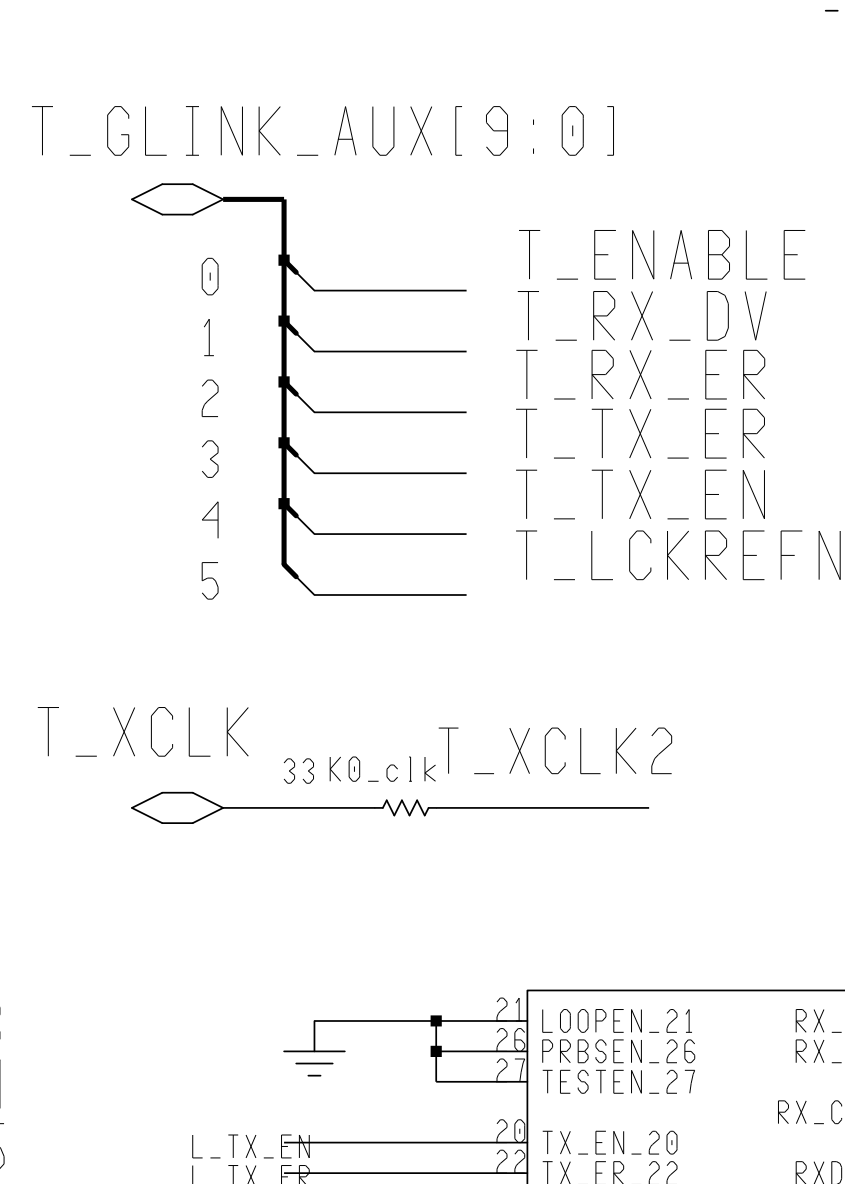
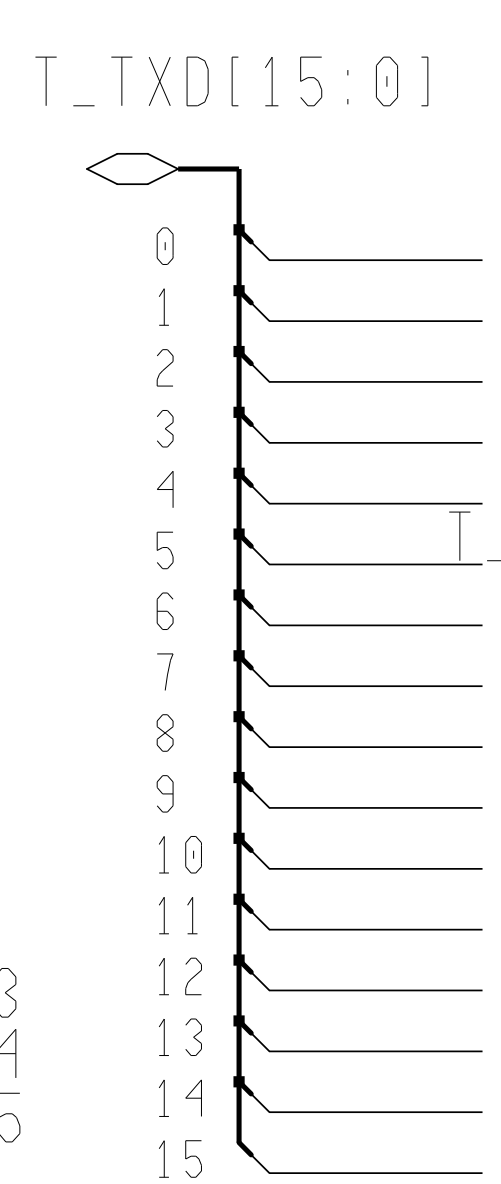
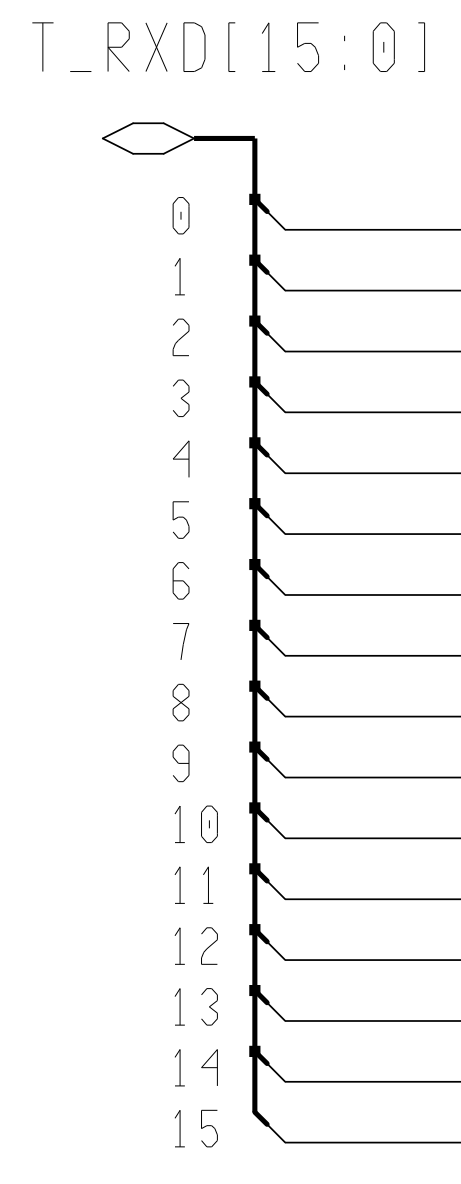
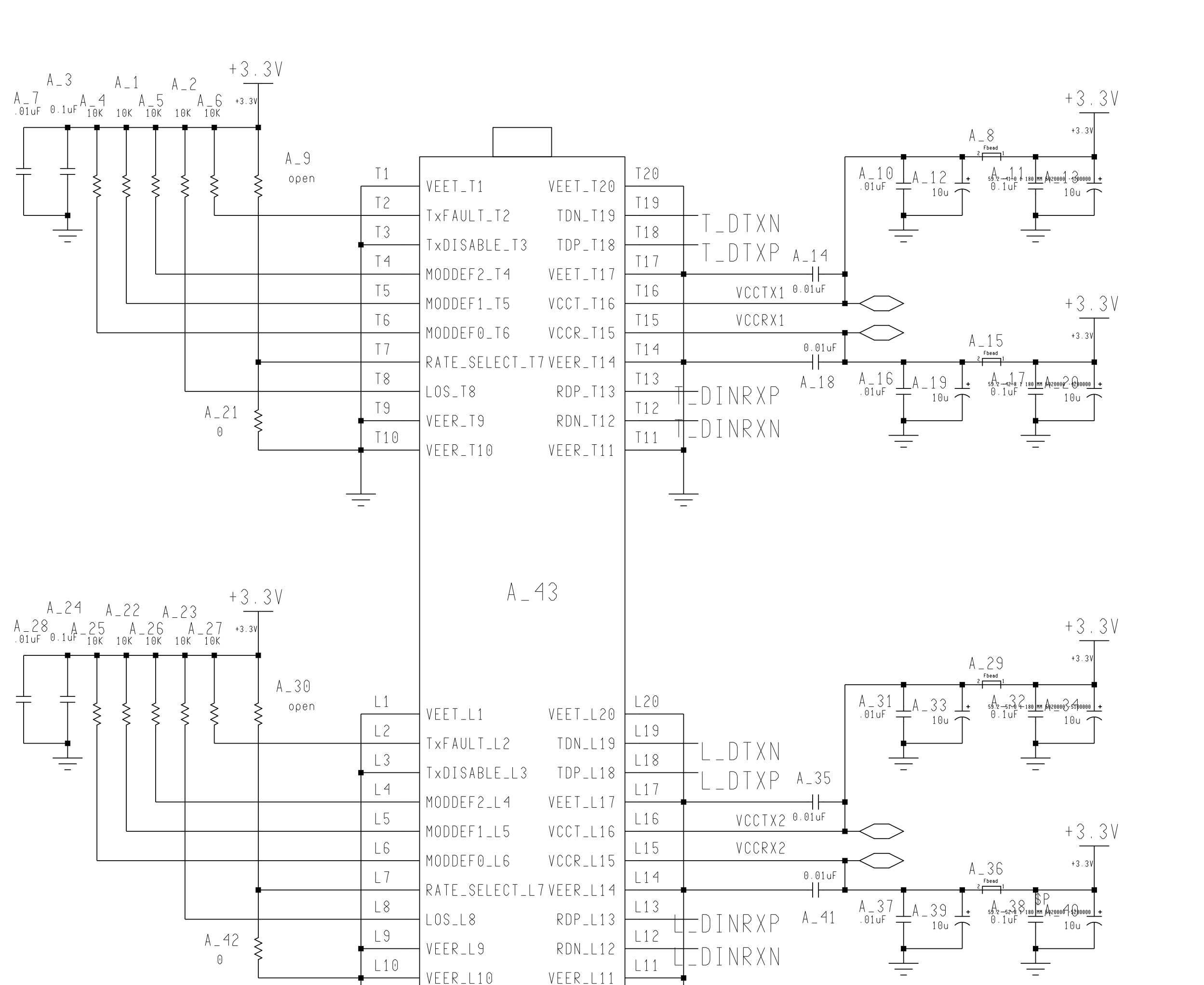
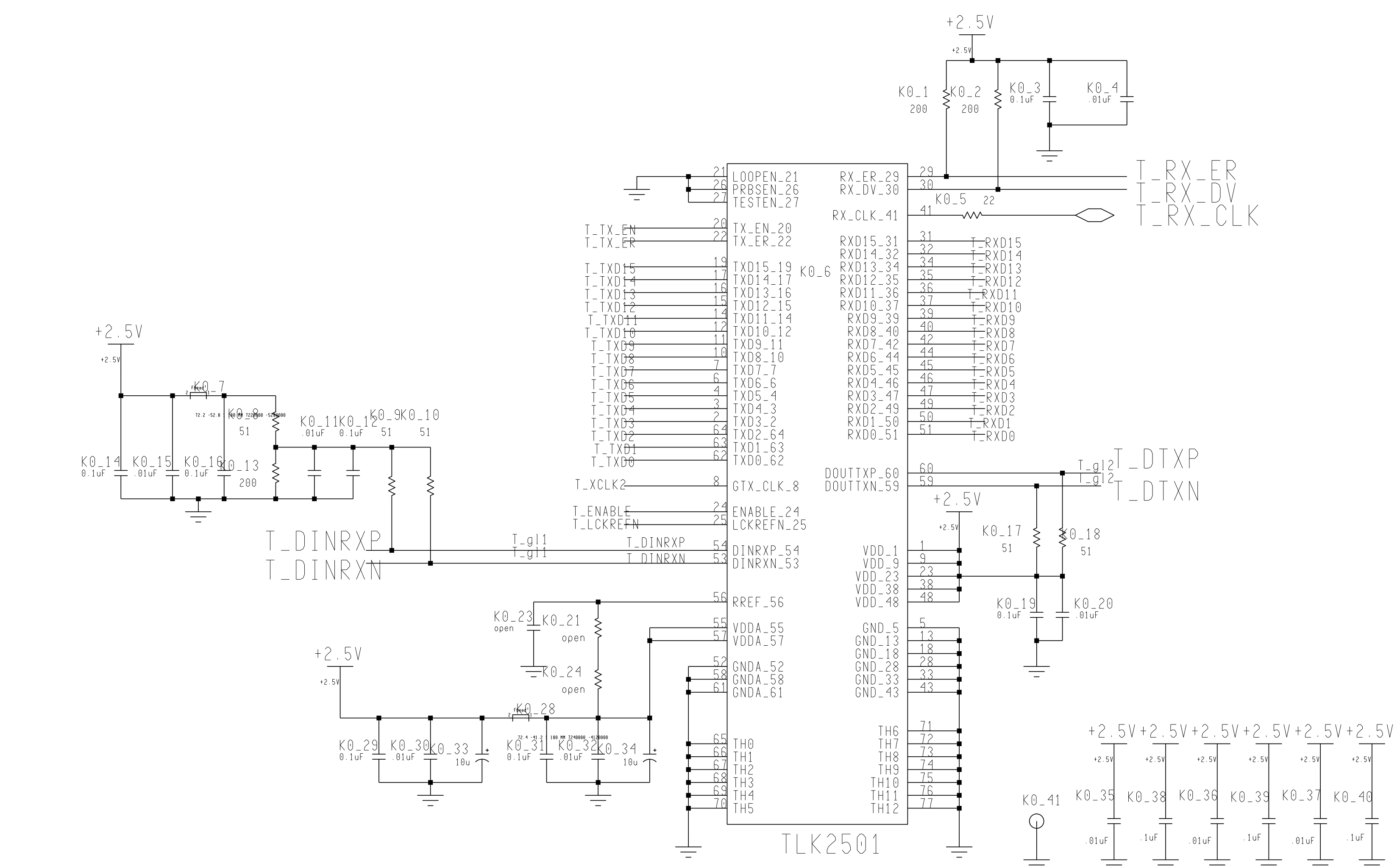

Engineer: **M. Bogdan**
 Drawn by: **M. Bogdan**
 DATE: **10/7/2017**
 SPC#2878 ASM#2879

Crate Distribution/Topology Module
Optical Links 0
The University of Chicago
 REV. A | DRW. **2877** | Sheet 2-1