

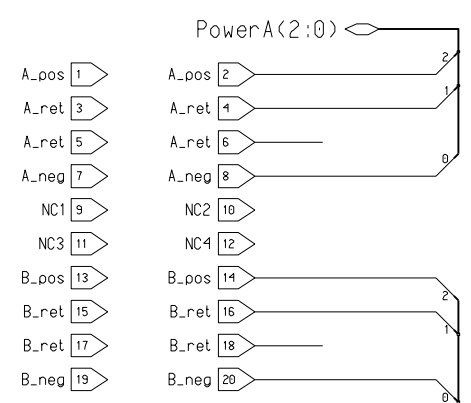

Front Panel Header

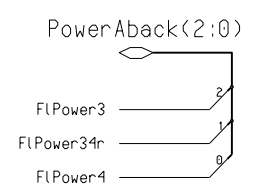

PowerB(2:0)



PowerAback(2:0)

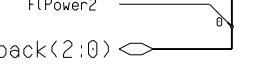

NCP21WF104J03RA by Murata

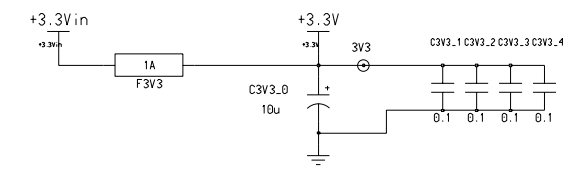
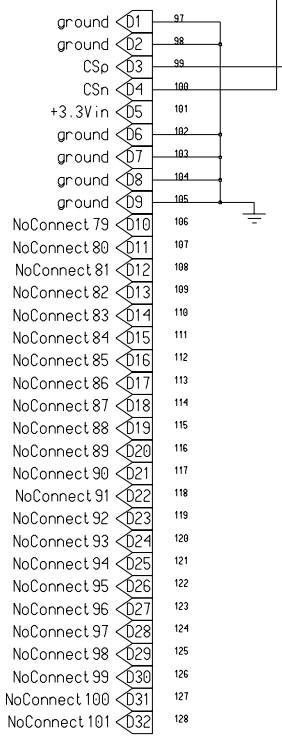
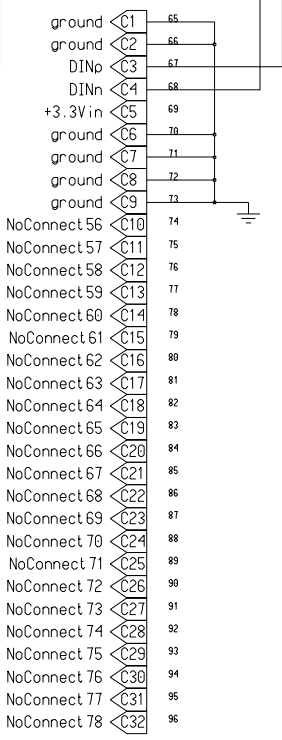
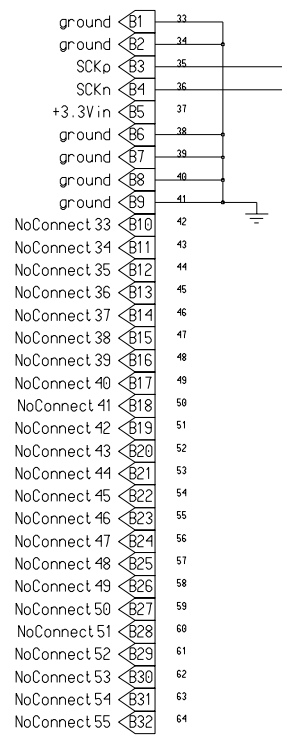
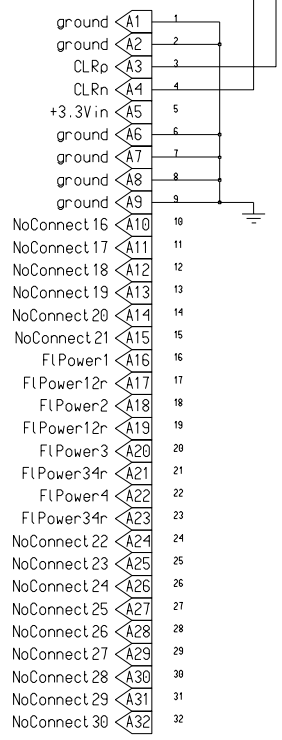
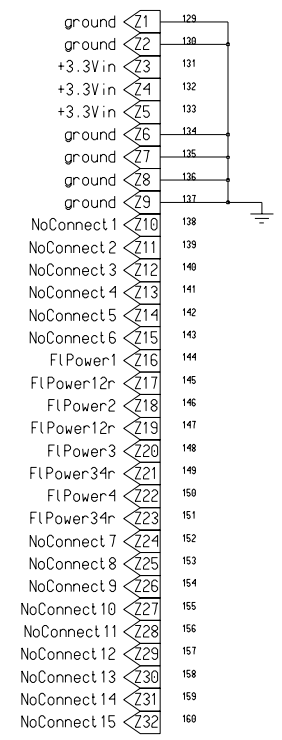
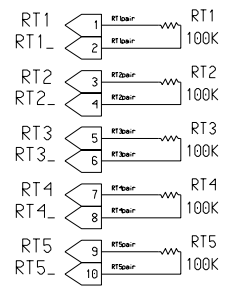

Design C. Bischoff, M. Bogdan	The University of Chicago 5640 S. Ellis Ave. Chicago, IL 60637	
Engineer M. Bogdan	TITLE	
R&D CHK	Size B	
DATE: 6/24/06	P1 Connector QUIET-PreAmp	
TIME: 2:00 pm		
QA CHK	REV A	DRW. B-2590 Sheet 4 of 6