

UNIVERSITY OF CHICAGO
ELECTRONICS DEVELOPMENT GROUP

CDF Level2 Trigger
Pulsar

SHEET	1 OF 25	C-2501
DATE	2001-12-03	REV A
DRWN	MB/TL	

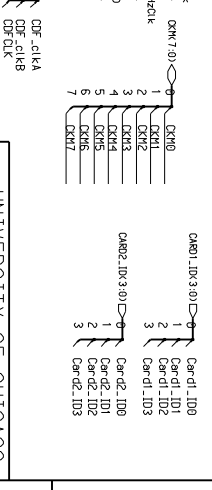
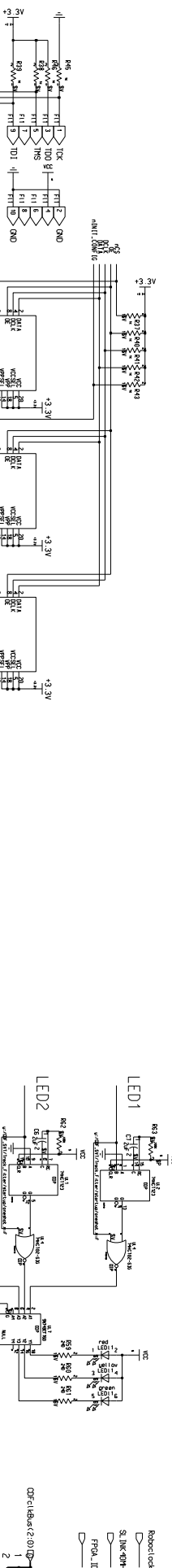
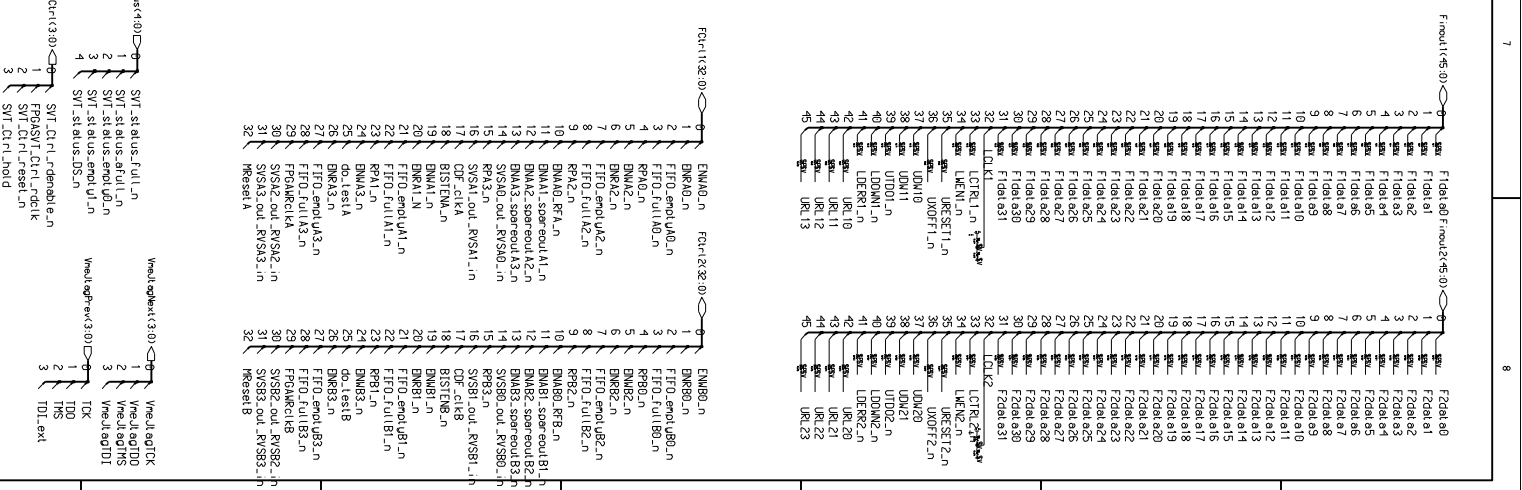
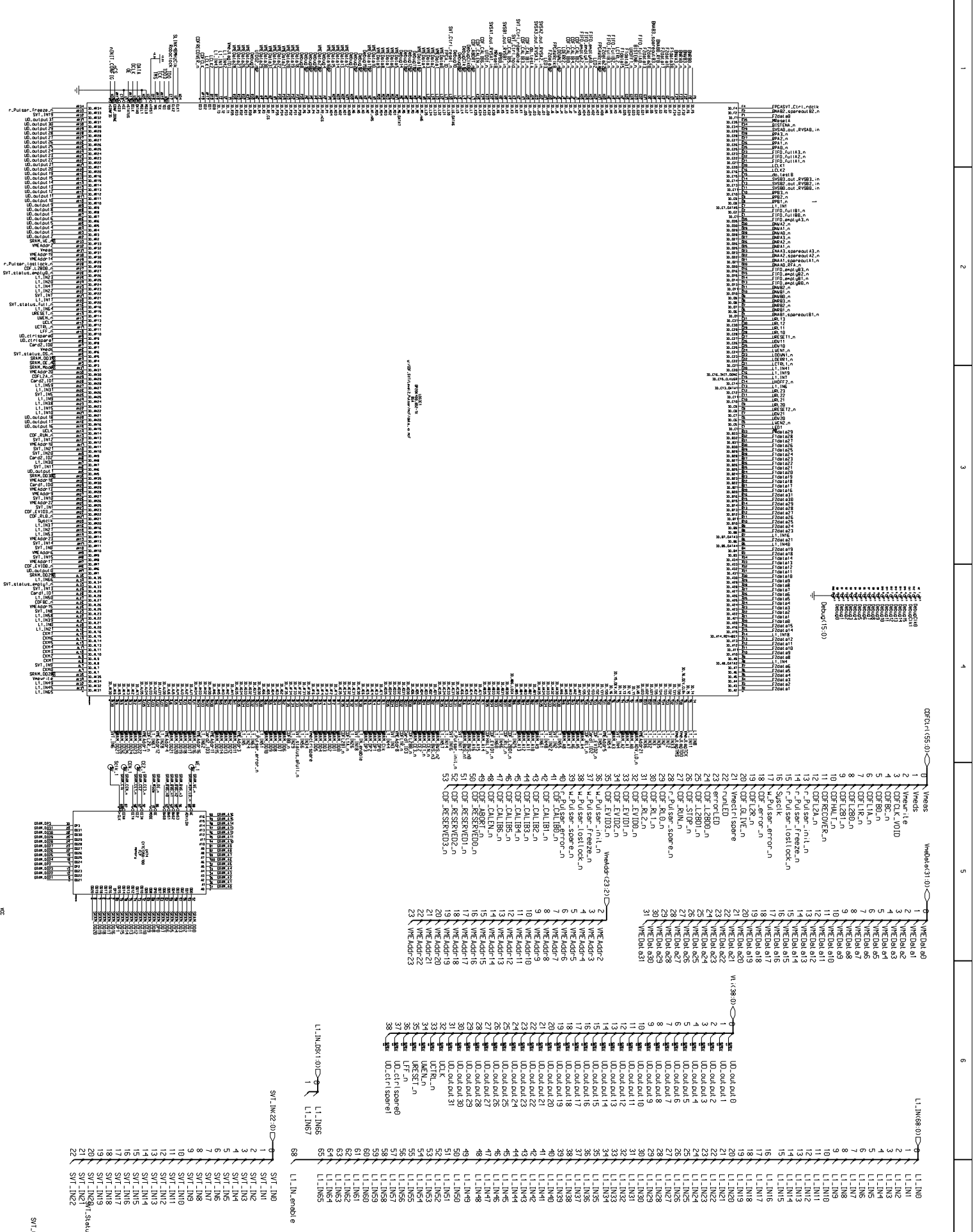

<p>UNIVERSITY OF CHICAGO Electronics Design Group</p> <p>TITLE: PULSAR</p> <p>MB/TL: 2002-03-01</p> <p>REV: Drawing Number 2 of 25</p> <p>Size: 0</p>	<p>Report lock: ON (7:0)</p> <p>SW: ON (2:0)</p> <p>SW: ON (3:0)</p> <p>SW: ON (4:0)</p> <p>SW: ON (5:0)</p> <p>SW: ON (6:0)</p> <p>SW: ON (7:0)</p> <p>SW: ON (8:0)</p> <p>SW: ON (9:0)</p> <p>SW: ON (10:0)</p> <p>SW: ON (11:0)</p> <p>SW: ON (12:0)</p> <p>SW: ON (13:0)</p> <p>SW: ON (14:0)</p> <p>SW: ON (15:0)</p> <p>SW: ON (16:0)</p> <p>SW: ON (17:0)</p> <p>SW: ON (18:0)</p> <p>SW: ON (19:0)</p> <p>SW: ON (20:0)</p> <p>SW: ON (21:0)</p> <p>SW: ON (22:0)</p> <p>SW: ON (23:0)</p> <p>SW: ON (24:0)</p> <p>SW: ON (25:0)</p> <p>SW: ON (26:0)</p> <p>SW: ON (27:0)</p> <p>SW: ON (28:0)</p> <p>SW: ON (29:0)</p> <p>SW: ON (30:0)</p> <p>SW: ON (31:0)</p> <p>SW: ON (32:0)</p>
---	---

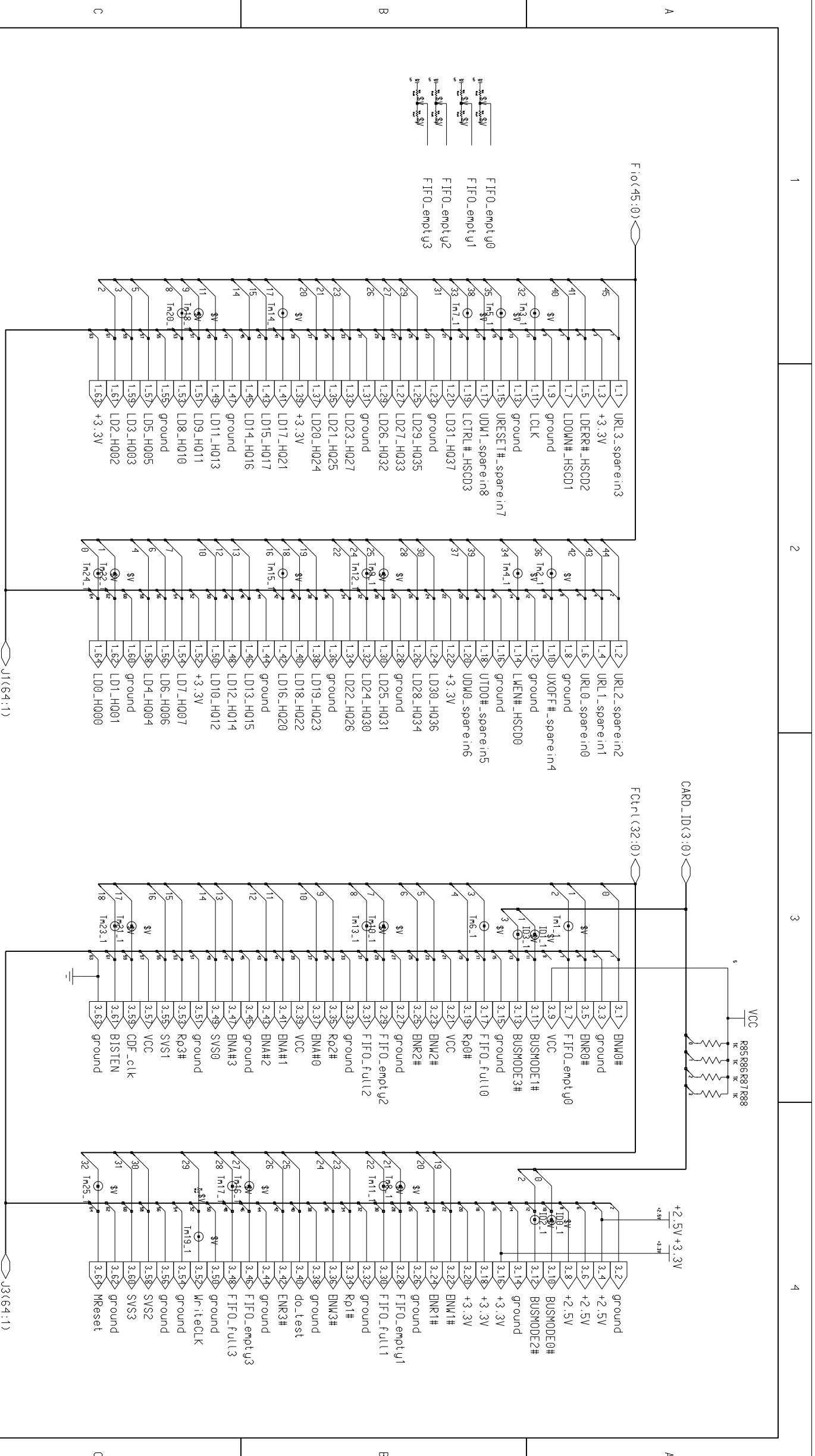

Note: the mezzanine card connector is a receptacle 64-pin surface-mount CMC connector.
 Note: FCTRL(32:0) is for optical IO mezzanine card control signals, not for SLINK
 FIO(45:0) is for SLINK LDC, but also for optical IO mezzanine card signals

Changed by	Date Changed	Time Changed
MB/TL	March 18, 2002	9:51:06 am

Engineer	MB/TL	COMPANY NAME
Drawn by	MB/TL	Address
R&D CHK		City
DOC CTRL CHK		TITLE
MFG ENGR CHK		Mezzanine_Card_1
		Pulsar
		Size
		C

REV	Drawing Number	Sheet	of
B	2501	3	25

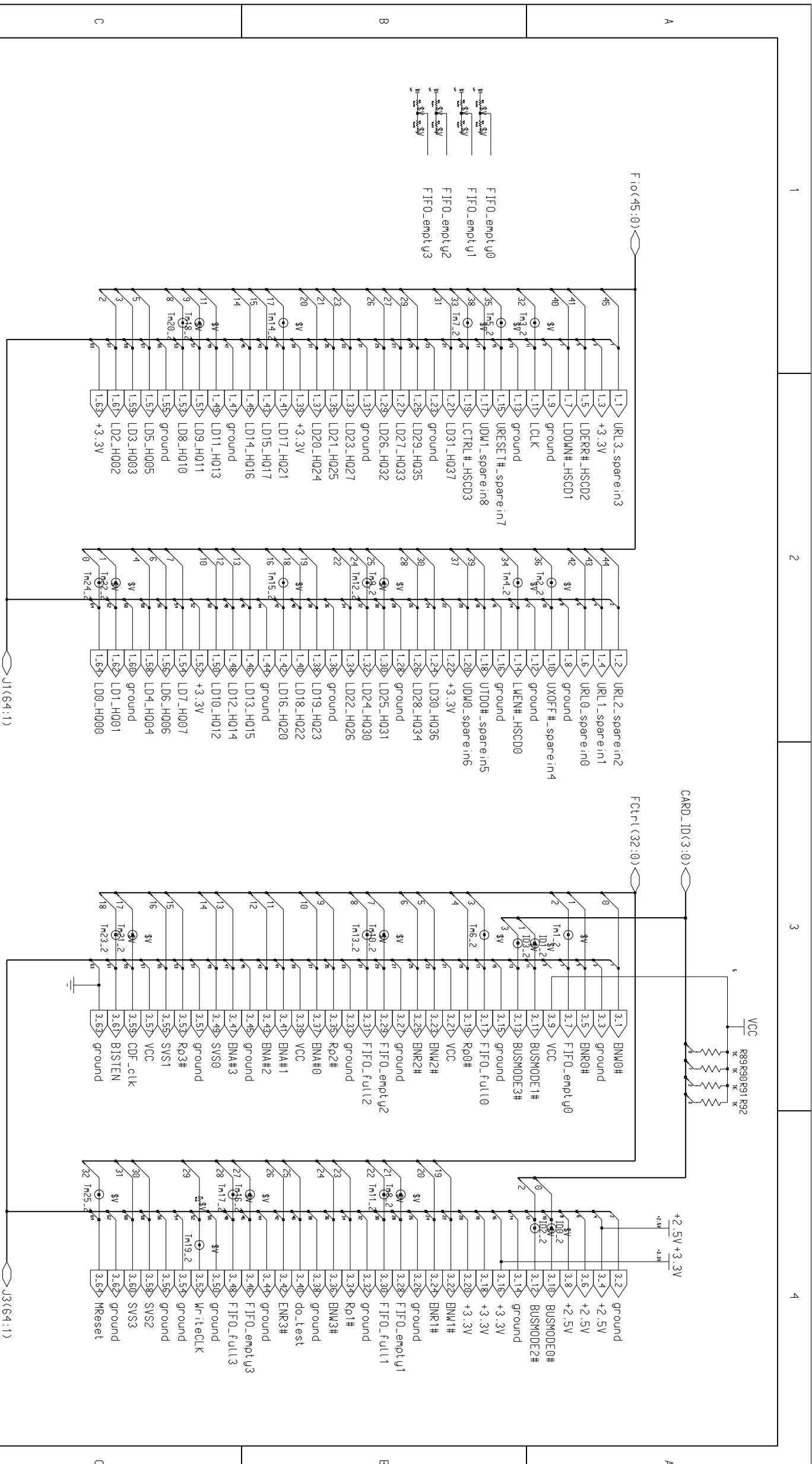

Note: the mezzanine card connector is a receptacle 64-pin surface-mount CMC connector.
 Note: FCTRL(32:0) is for optical IO mezzanine card control signals, not for SLINK
 FIO(45:0) is for SLINK LDC, but also for optical IO mezzanine card signals

Changed by MB/TL	Date Changed March 18, 2002	Time Changed 9:51:06 am	QA CHK	REV B	Drawing Number 2501	Sheet 4 of 25
---------------------	--------------------------------	----------------------------	--------	----------	------------------------	---------------

Engineer MB/TL	COMPANY NAME Address City
Drawn by MB/TL	
R&D CHK	
DOC CTRL CHK	TITLE Mezzanine_Card_2
MFG ENGR CHK	PULSAR
	Size C

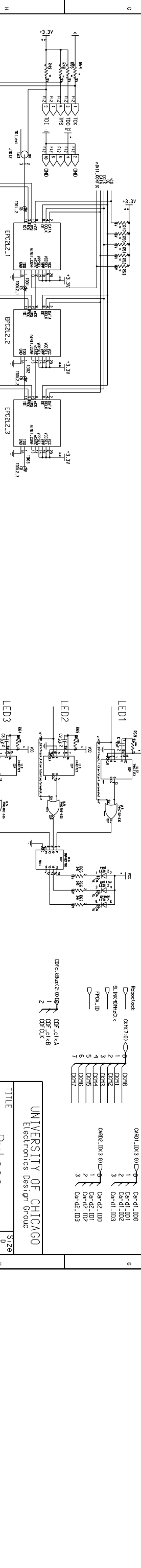
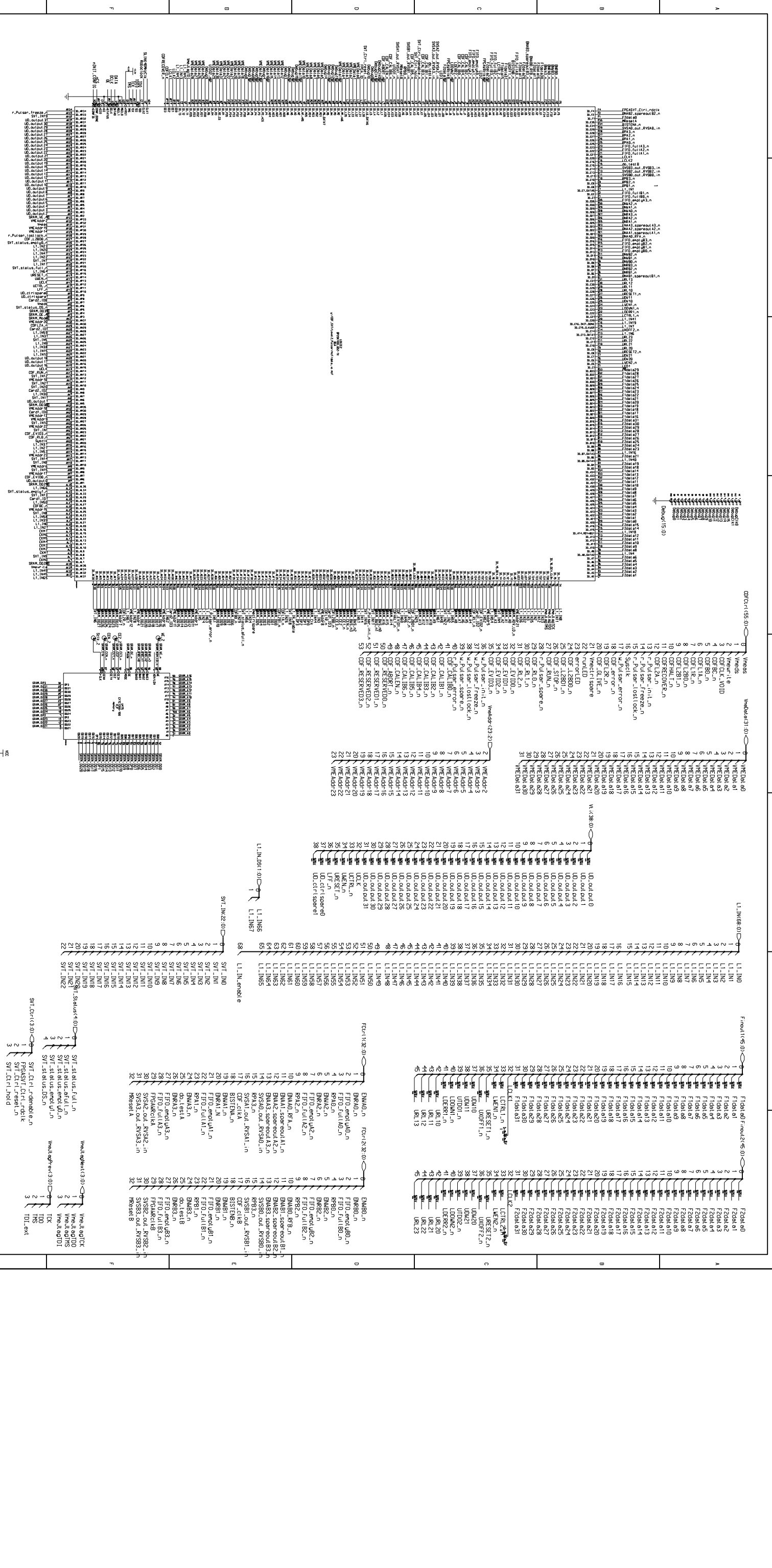

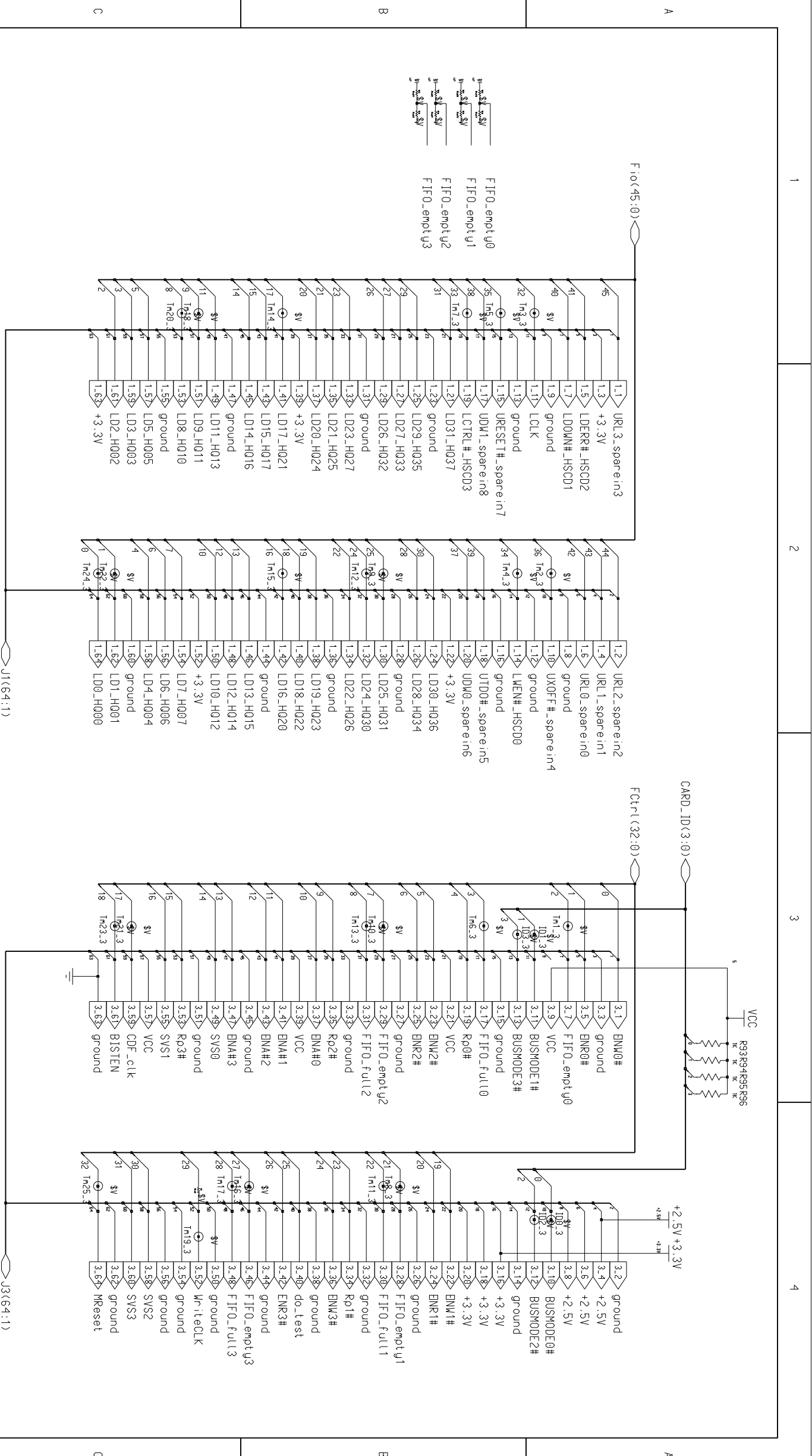

Note: the mezzanine card connector is a receptacle 64-pin surface-mount CMC connector.
 Note: FCtrl(32:0) is for optical I/O mezzanine card control signals, not for SLINK
 Fio(45:0) is for SLINK LDC, but also for optical I/O mezzanine card signals

Changed by MB/TL	Date Changed March 18, 2002	Time Changed 9:51:06 am	QA CHK	REV B	Drawing Number 2501	Sheet 6 of 25
---------------------	--------------------------------	----------------------------	--------	----------	------------------------	---------------

Engineer MB/TL	COMPANY NAME Address City
Drawn by MB/TL	
R&D CHK	
DOC CTRL CHK	
MFG ENGR CHK	TITLE Mezzanine_Card_3 PULSAR
	Size C

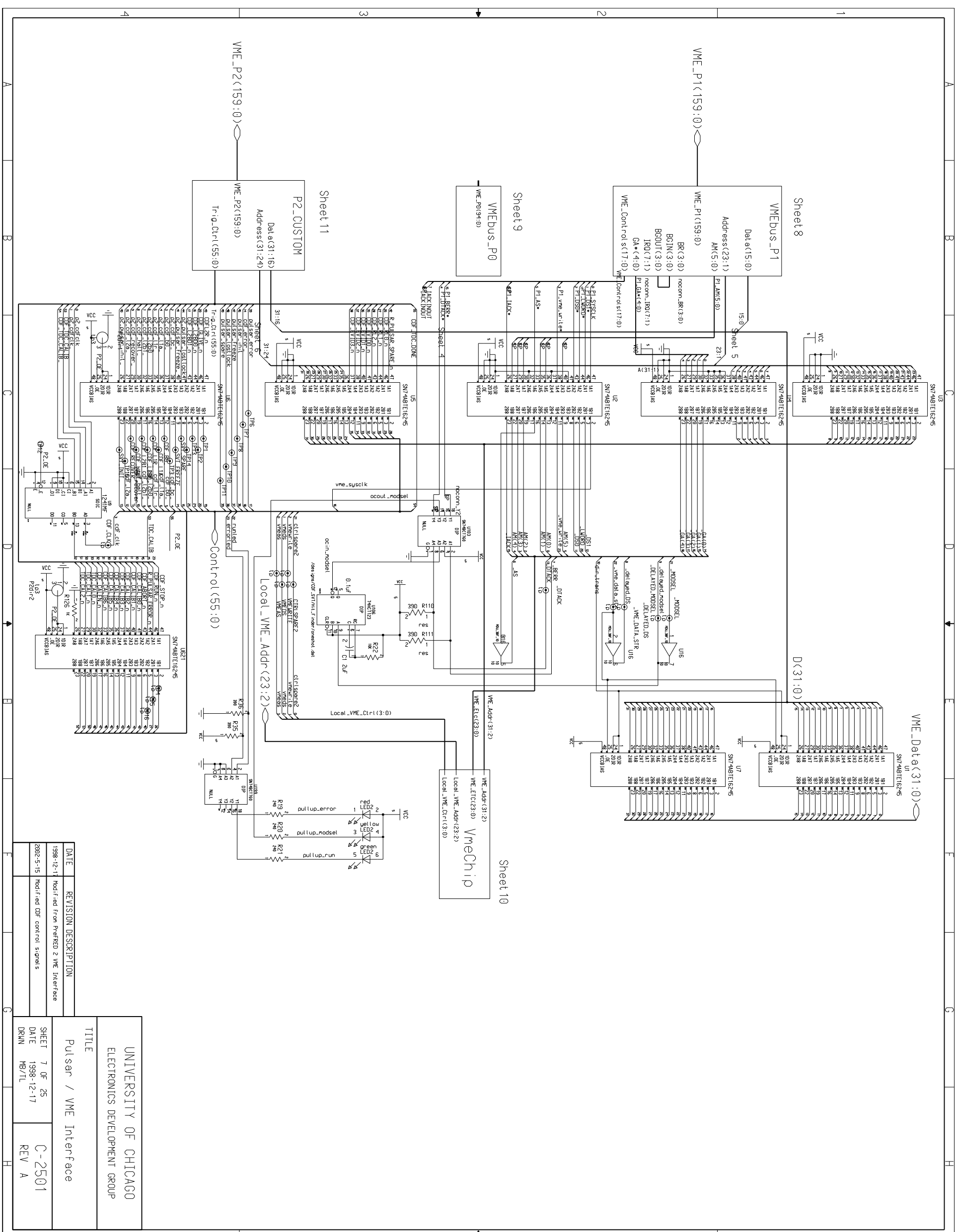

DATE	REVISION DESCRIPTION
1998-12-17	Modified from Preferred 2 VME Interface
2002-5-15	Modified CDF control signals

TITLE	
UNIVERSITY OF CHICAGO ELECTRONICS DEVELOPMENT GROUP	
Pulsar / VME Interface	
SHEET	7 OF 25
DATE	1998-12-17
DRWN	MB/TL
	REV A

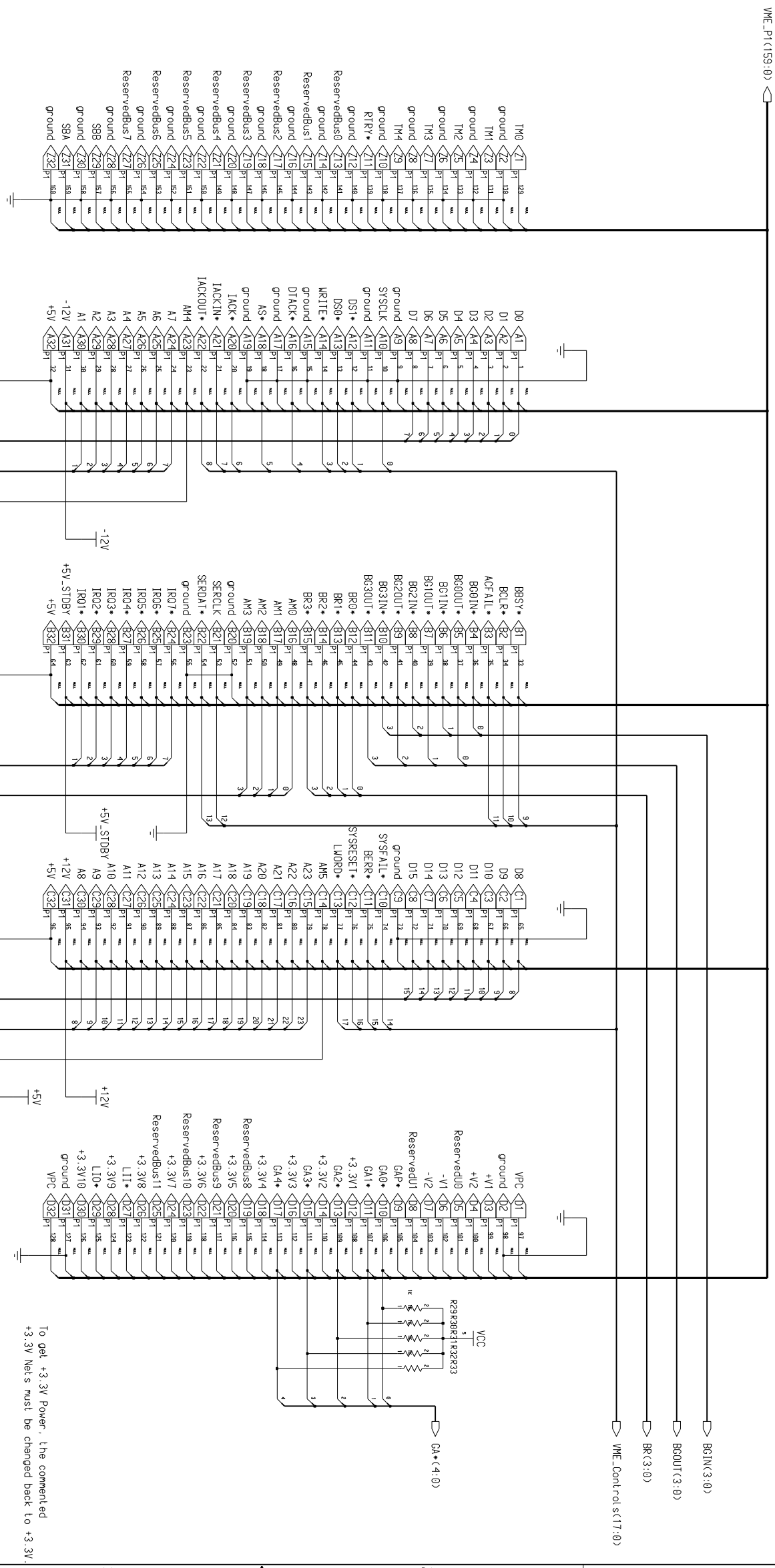

P1

Rows Z and D are in accordance with the VME64 Extensions standard. Note: the positioning of rows A, B and C should be in accordance with the VME Standard.

To get +3.3V Power, the commented +3.3V Nets must be changed back to +3.3V

1: 234
2: 27
3: 4.11 0 INTRIMM00 -2000
ISV

DATE	REVISION DESCRIPTION
1998-12-1	Copied from PrefRdz P1 -- MAB/KJA
2002-03-26	modified for Pulsar (MB/LI)

TITLE		UNIVERSITY OF CHICAGO ELECTRONICS DEVELOPMENT GROUP	
Pulsar VMEbus_P1			
SHEET 8 OF 25	DATE 18 Nov 1996	C-2501	
DRN JH		REV A	

P0

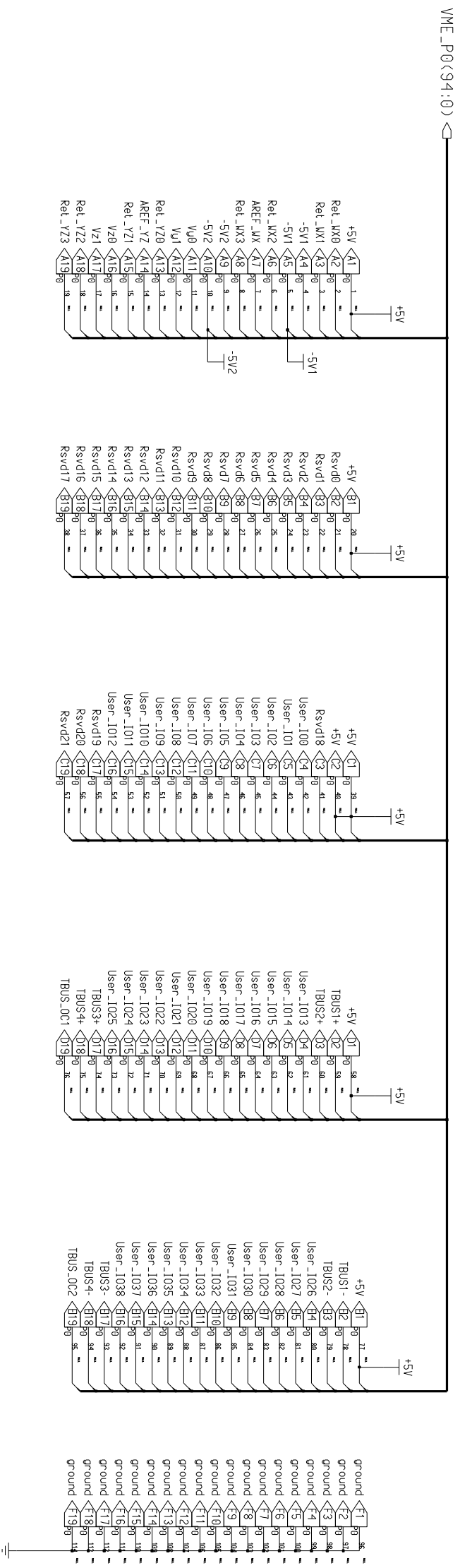

DATE	REVISION DESCRIPTION	TITLE
1998-12-11	Copied from PrefREQ2 P0 Rev C -- HMB/MA	UNIVERSITY OF CHICAGO ELECTRONICS DEVELOPMENT GROUP
		Pulsar VMEbus_P0

SHEET	9 OF 25	C-2501
DATE	18 Nov 1996	
DRN	JM	REV A

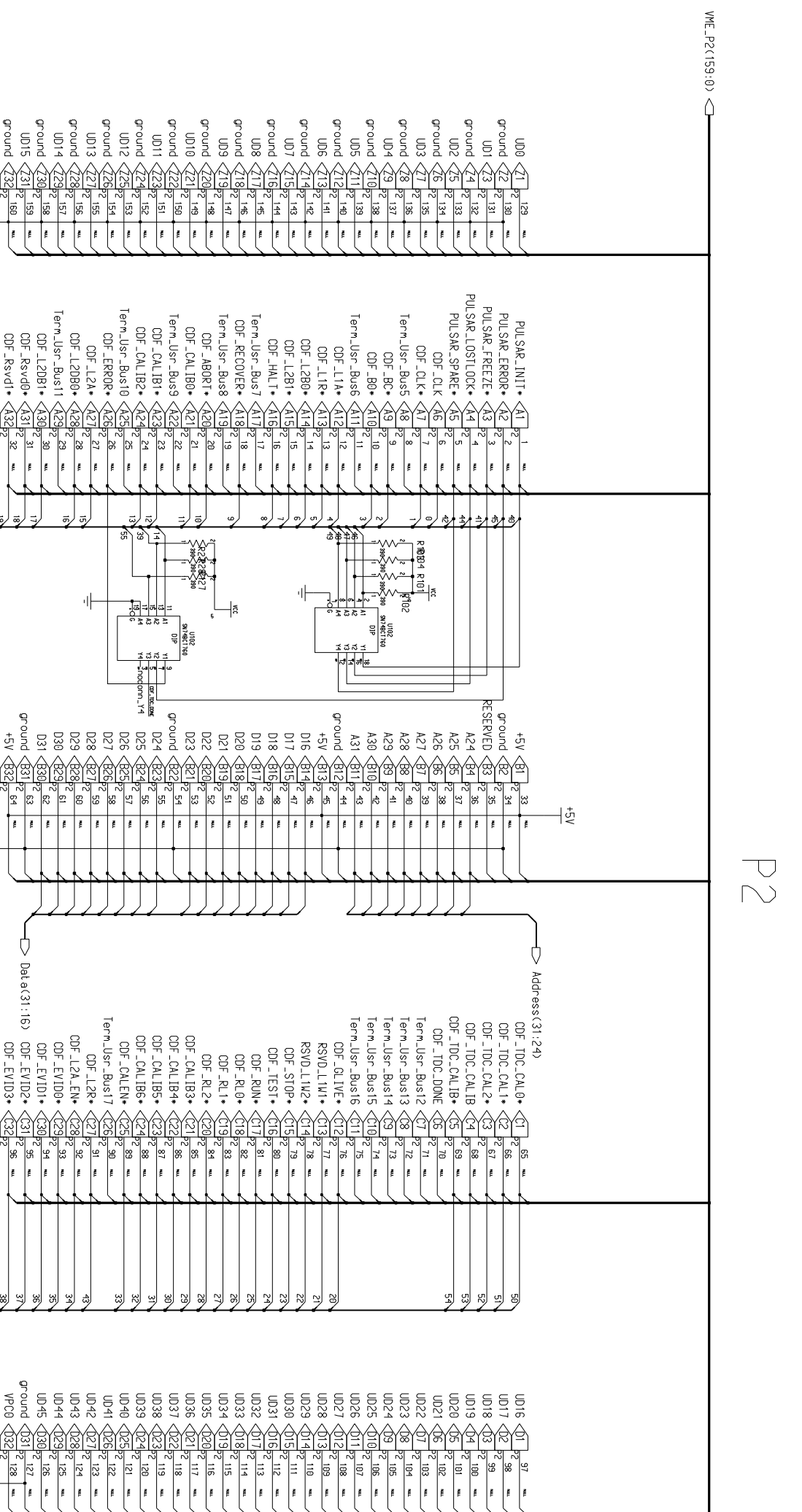

Rows Z and D are in accordance with the VME64 Extensions standard. Note: the positioning of rows A, B and C should be in accordance with the VME Standard.

All user-defined signals on P2 are totem-pole TTL excluding:
 a. Geographical Addresses are pulled-up/grounded wires
 b. 132ns Clock is differential PECL: CLK - CLK*
 c. ERROR* is open collector TTL

UNIVERSITY OF CHICAGO ELECTRONICS DEVELOPMENT GROUP		TITLE Pulsar / VMEbus_P2	
DATE	REVISION DESCRIPTION	SHEET 11 OF 25	C - 2501
1998-12-17	Started from PrefE02 P2 Rev C -- HW/KJA	DATE 18 Nov 1996	REV A
2002-03-28	Added SVI-specific A1-A5 signals -- KJA modified for Pulsar (R8/TL)	DRN JM	

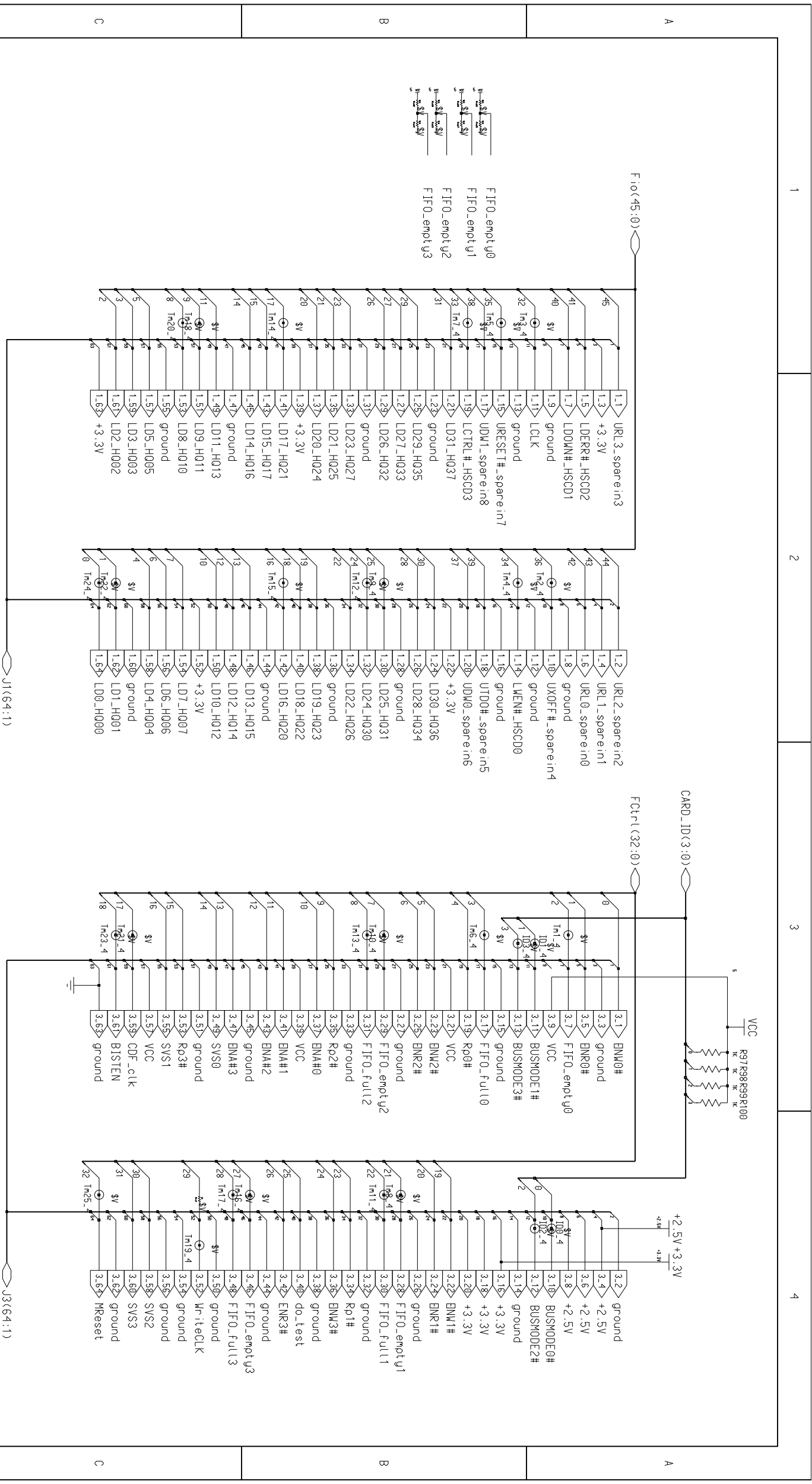

Note: the mezzanine card connector is a receptacle 64-pin surface-mount CMC connector.
 Note: FCTRL(32:0) is for optical IO mezzanine card control signals, not for SLINK
 FIO(45:0) is for SLINK LDC, but also for optical IO mezzanine card signals

Changed by MB/TL	Date Changed March 18, 2002	Time Changed 9:51:06 am	QA CHK	REV B	Drawing Number 2501	Sheet 12 of 25
---------------------	--------------------------------	----------------------------	--------	----------	------------------------	----------------

Engineer MB/TL	COMPANY NAME Address City
Drawn by MB/TL	
R&D CHK	
DOC CTRL CHK	TITLE Mezzanine_Card_4
MFG ENGR CHK	PULSAR
	Size C

The L1 input signal map is based on Fred inputs on the interface board side. Note that the L1 output connector pin map is based on Fred signals on the Fred side. Need to remap the signals in firmware for Prefred signals.

the 64 L1 trigger bits are sent into FPGA as L1_IN(63:0), while L1Buffer bits (1:0) are L1_IN(65:64), and strobe 2 and 1 are L1_IN(67:66), and L1_IN(68) is the enable bit.

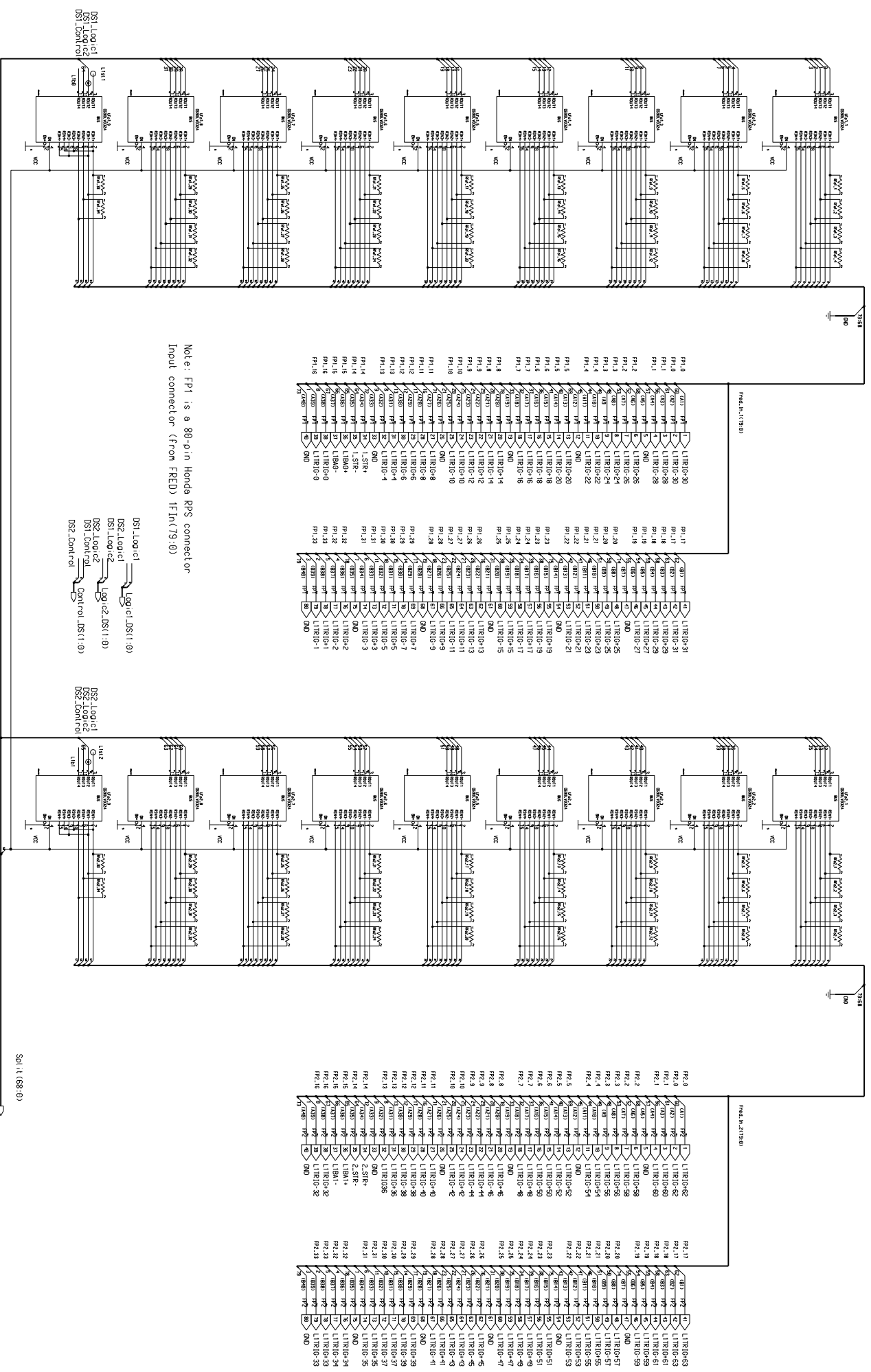

DATE	REVISION DESCRIPTION
2005-03-01	Completed the signal mapping (MPL)
2005-03-01	Added extra strobes.
2005-03-01	REV A

UNIVERSITY OF CHICAGO
ELECTRONICS DEVELOPMENT GROUP

TITLE Pulsar
Level 1 Inputs

SHEET 13 OF 25
DATE 2005-03-01
REV A

5-row P3 connector map to one SLINK LDC and one LSC (use P2-type backplane).
 the signals into control FPGA are mapped in such a way to be consistent with the mezzanine card connector, to make life easier in firmware
 The 32 data bits are mapped to S_IO<31:0>, other signals are mapped to higher bits. the mapping is similar for both LDC and LSC signals.

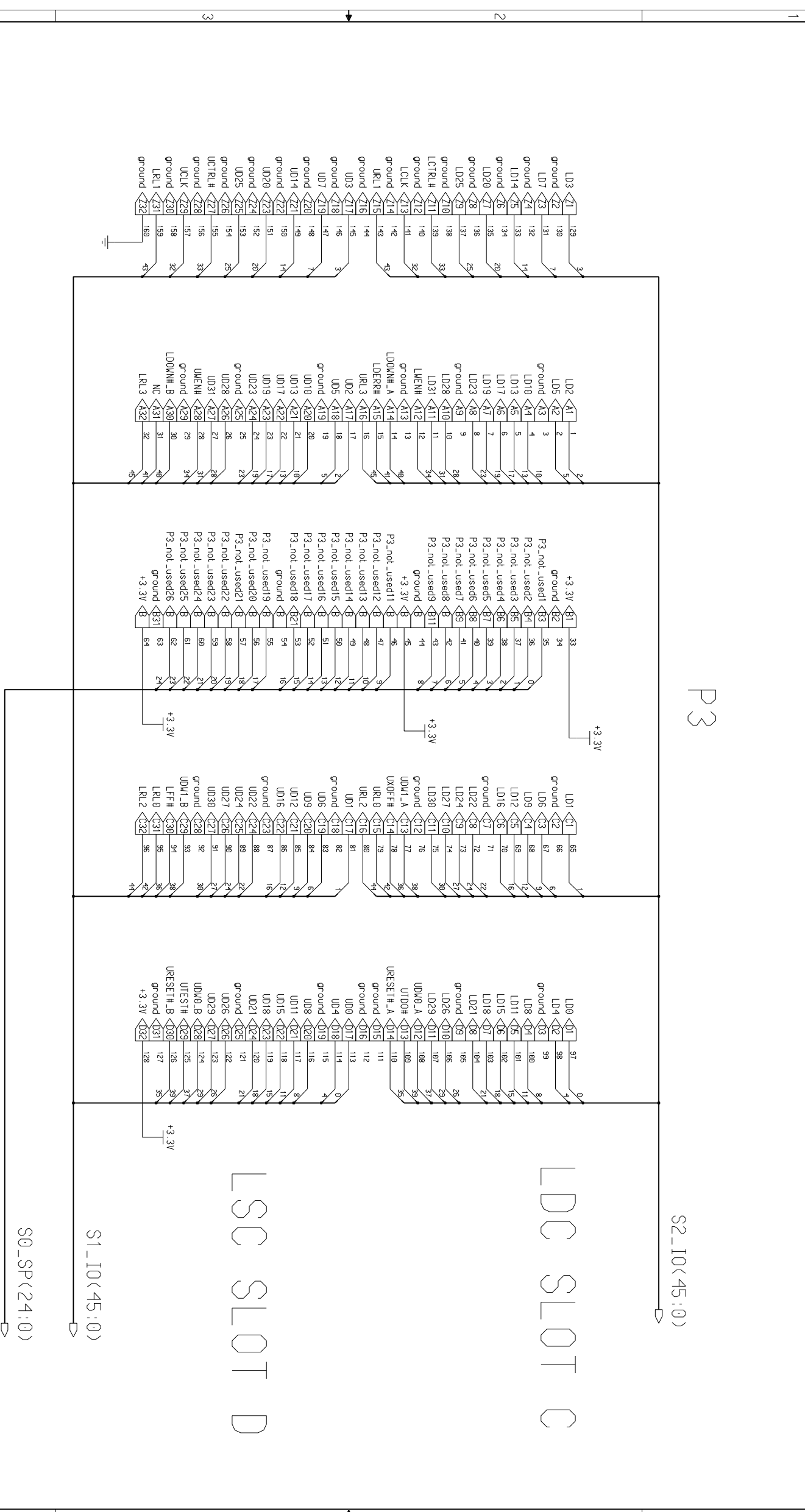

UNIVERSITY OF CHICAGO ELECTRONICS DEVELOPMENT GROUP	
TITLE Level2 Pulsar / P3	
DATE	REVISION DESCRIPTION
SHEET 14 OF 25	C-2501
DATE 5/15/2002	REV A
DRN MB/TL	

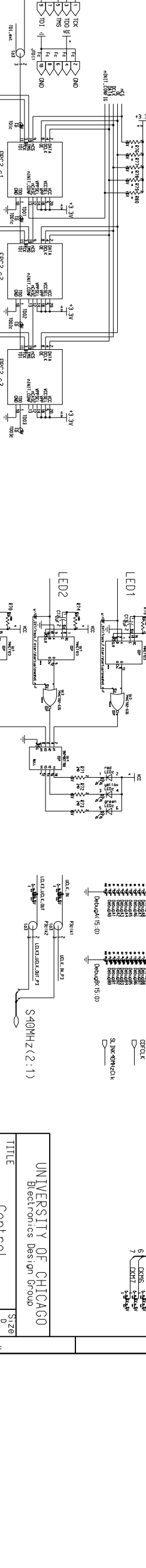
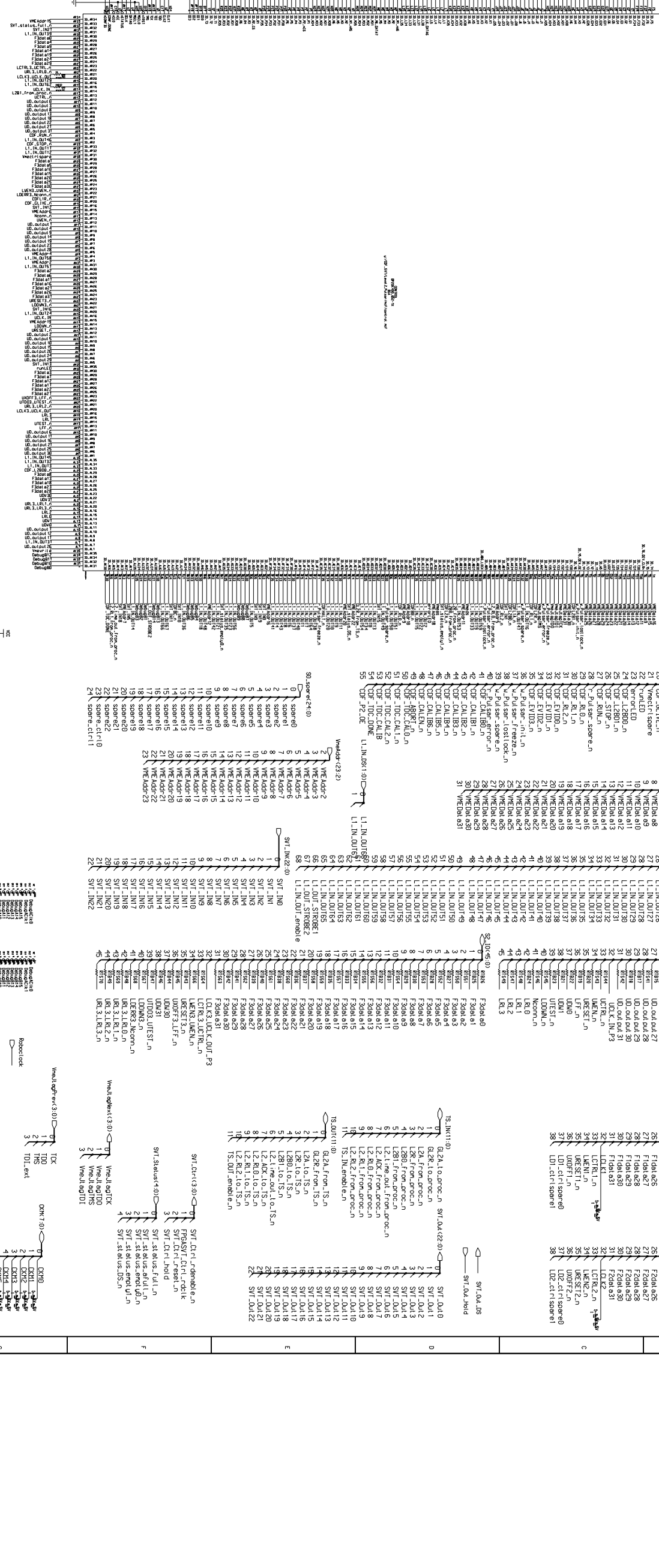
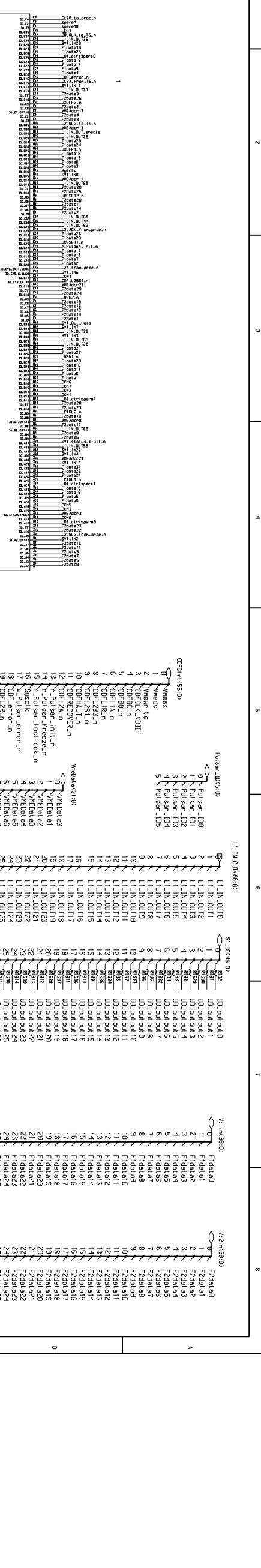

UNIVERSITY OF CHICAGO
Electronics Design Group

TITLE: Control

Size: B

REV: 2002-03-01

MB/TJL

2002-03-01

REV: Drawing Number Sheet 15 of 25

The L1 input signal map is based on Fred inputs on the interface board side. Note that the L1 output connector pin map is based on Fred signals on the Fred side. Need to remap the signals in firmware for Prefred signals.

the 64 L1 trigger bits are sent into FPGA as L1_INK(63:0), while L1Buffer bits (1:0) are L1_INK(65:64), and strobe 2 and 1 are L1_INK(67:66), and L1_INK(68) is the enable bit.

FP1: optional output to L2 processors

Note: FP1 is a 80-pin Honda connector

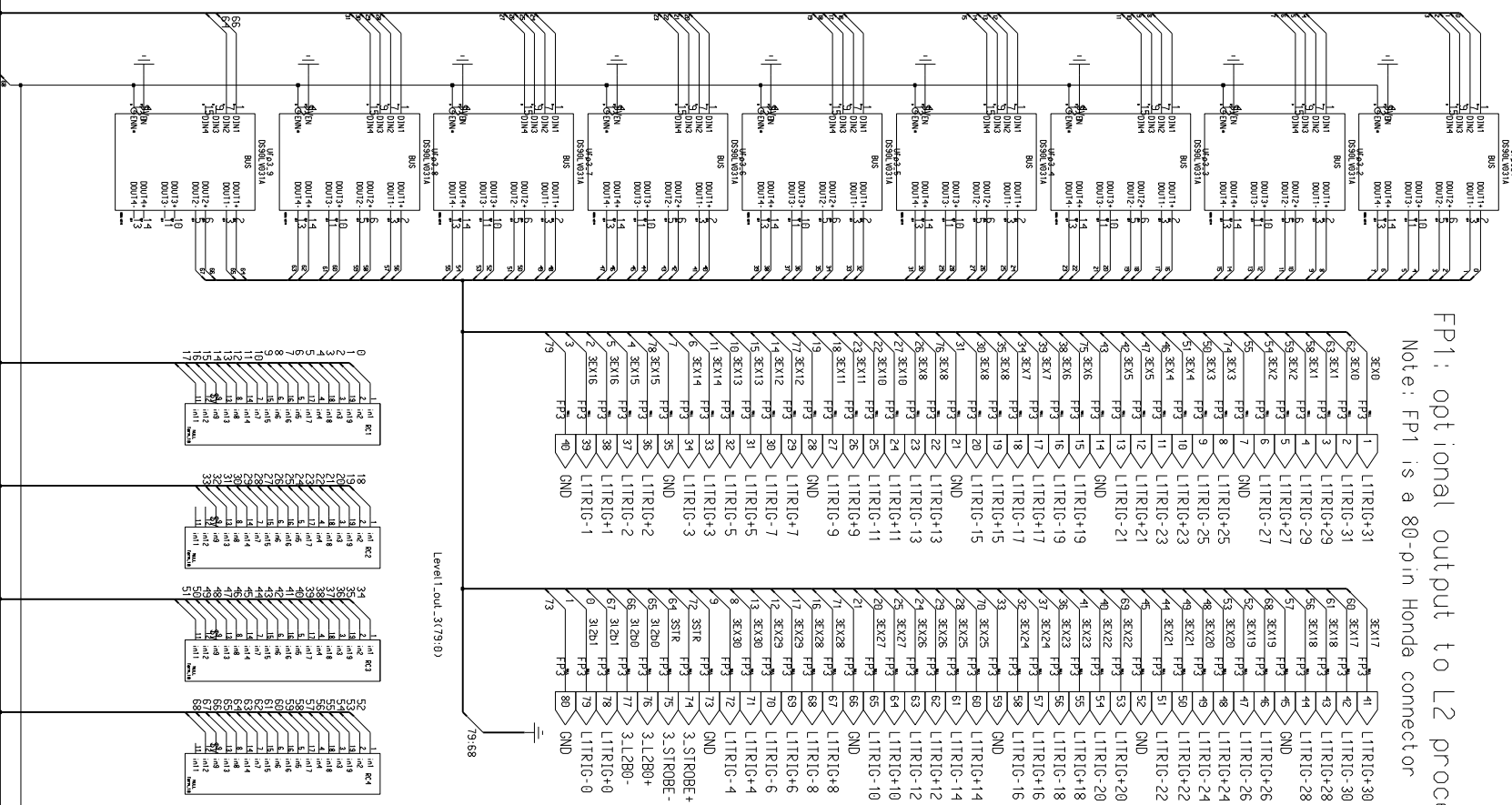

FP1: optional output to L2 processors

Note: FP1 is a 80-pin Honda connector

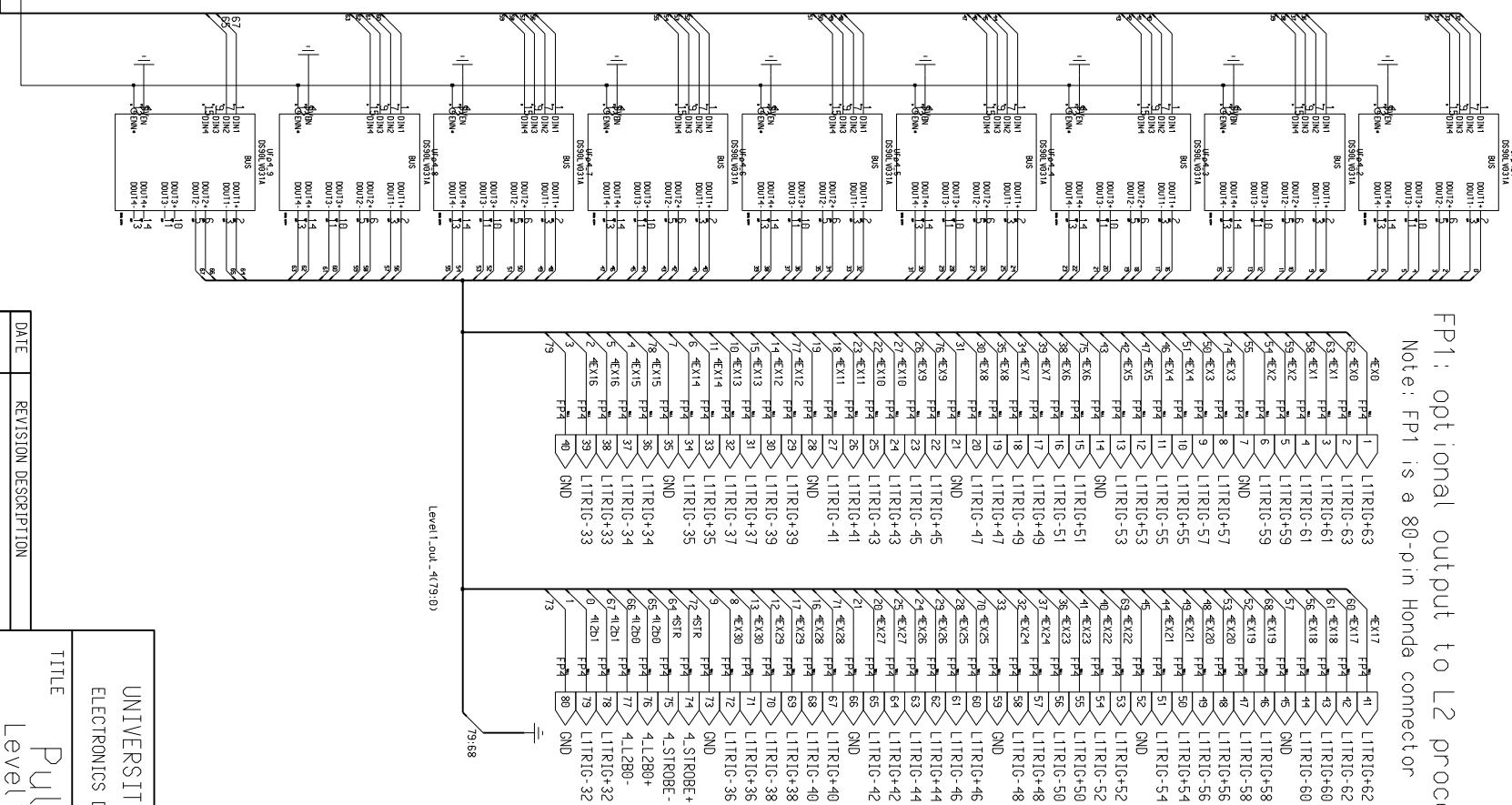

L1_Ink(68:0)

L1_Ink(67:4)

DATE	REVISION DESCRIPTION	SHEET	OF
2001-04-23	Post-Buster customization from Prefred	16	25
2001-04-23	Changed Pin Mapping to FRED(HB/L1)	DATE	2001-04-23
DRN	KJA/MAB	REV	A

UNIVERSITY OF CHICAGO
ELECTRONICS DEVELOPMENT GROUP

Pulsar
Level 1 Out

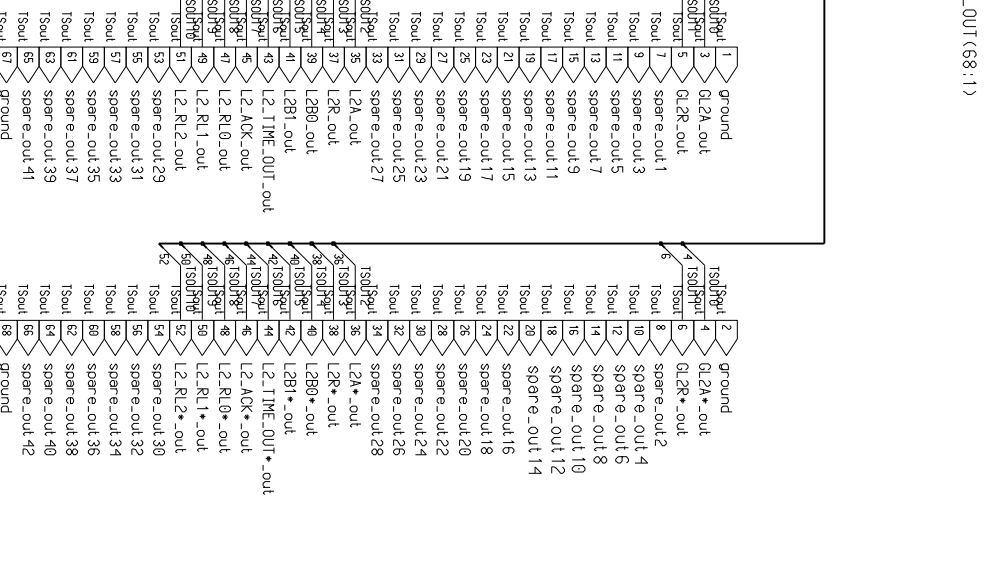
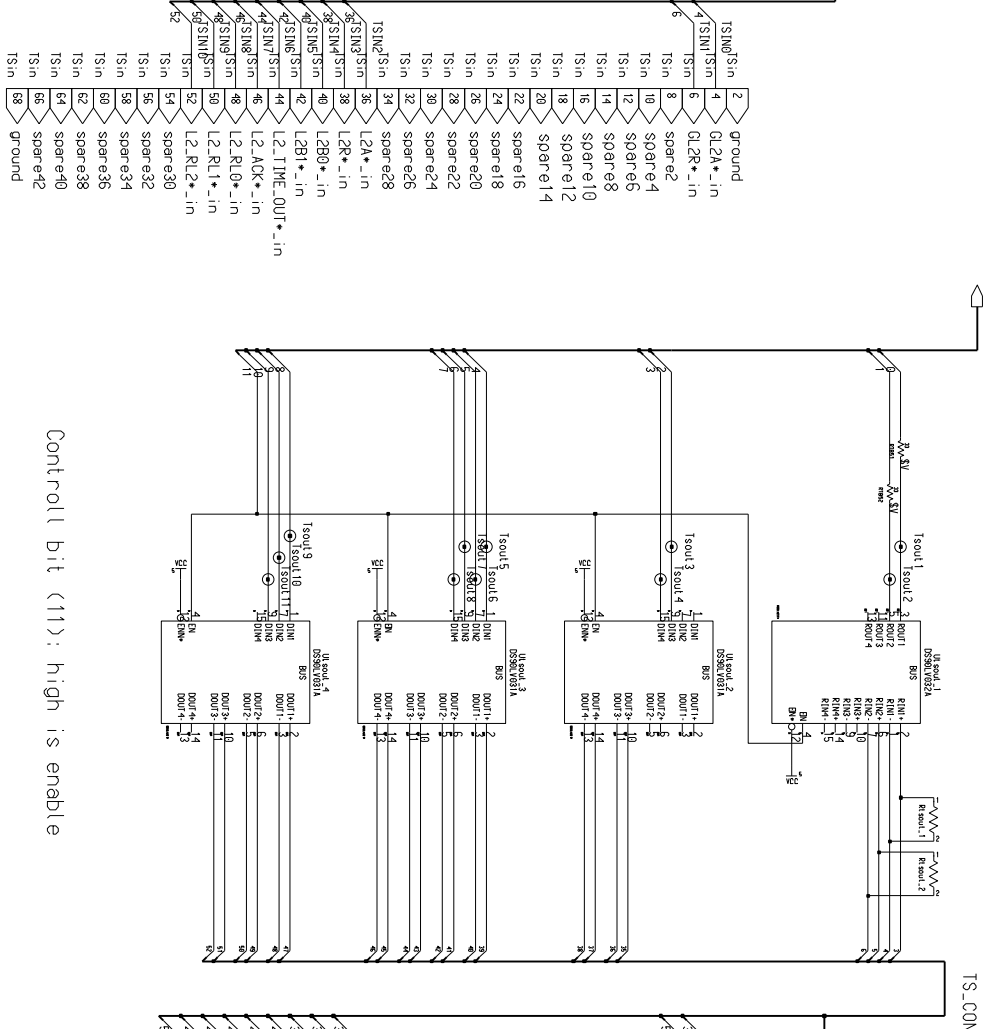
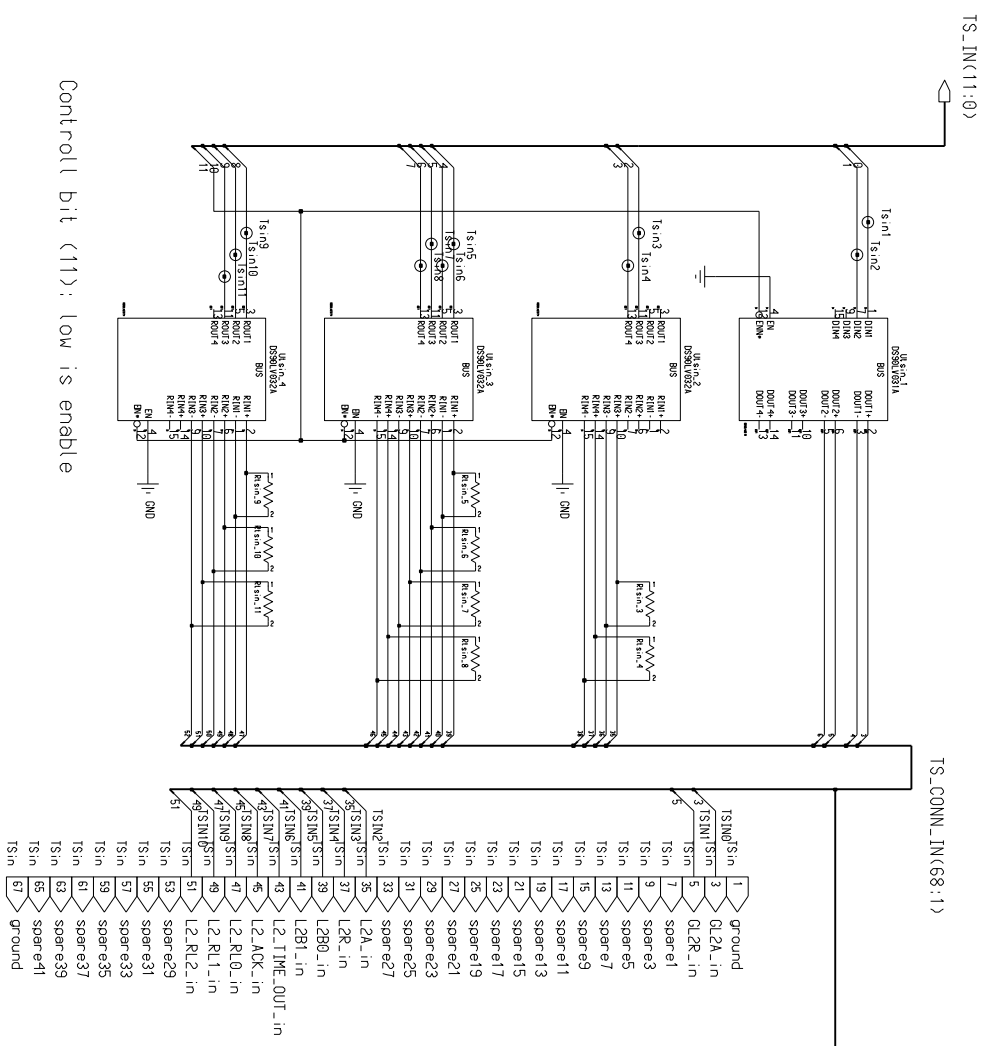

Changed by	Date Changed	Time	QA CHK	REV	Drawing Number	Sheet
Dogdan	Wednesday, February 27, 2002	1:23:36 pm				17 of 25

ENGINEER	COMPANY NAME Address City
Drawn By	
R&D CHK	
DOC CTRL CHK	
MFG CTRL CHK	
TITLE	Pulsar
TS-1/0	
Size	D

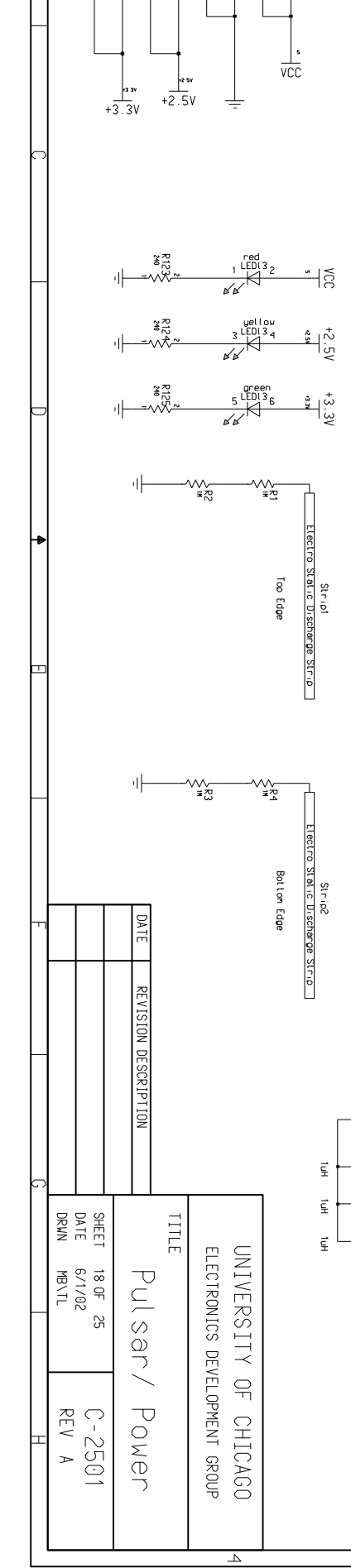
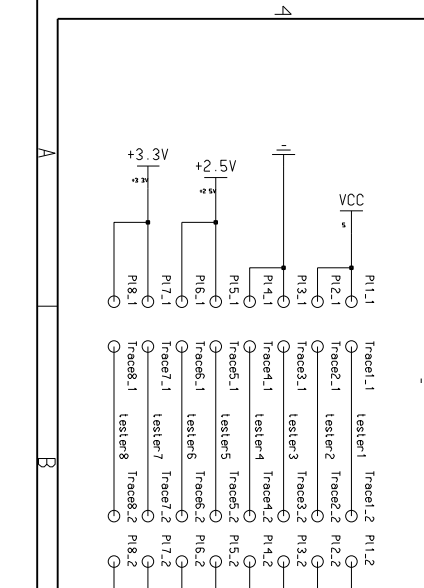
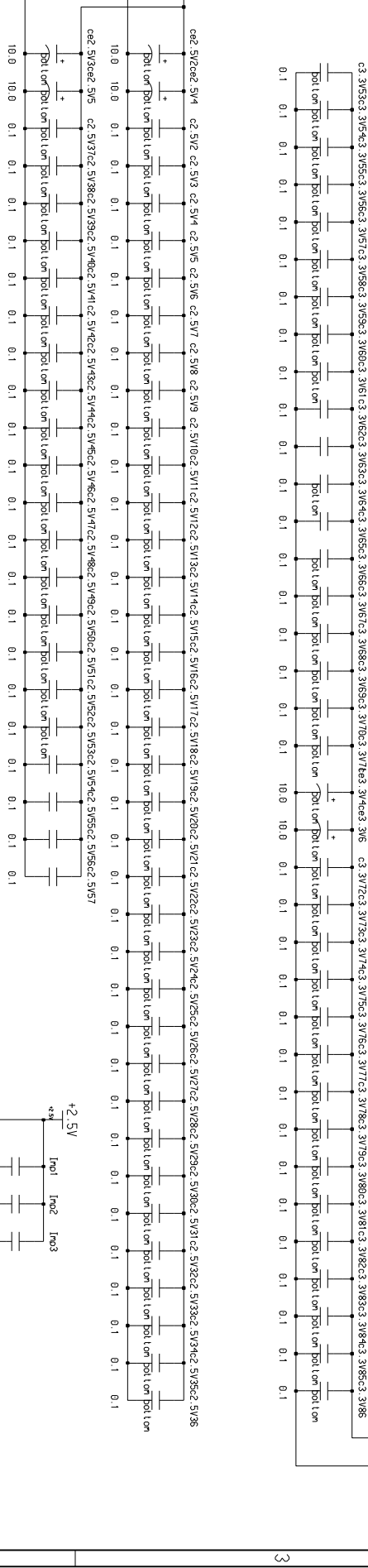
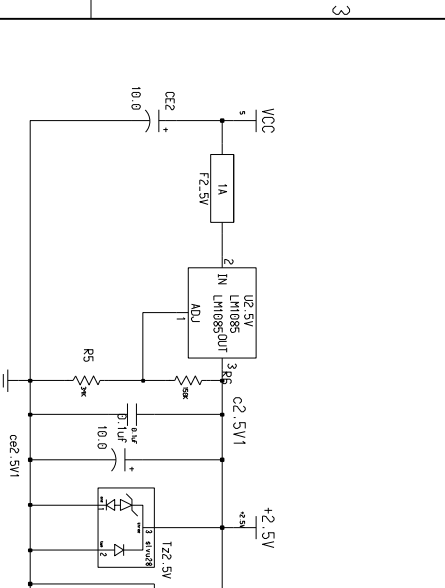
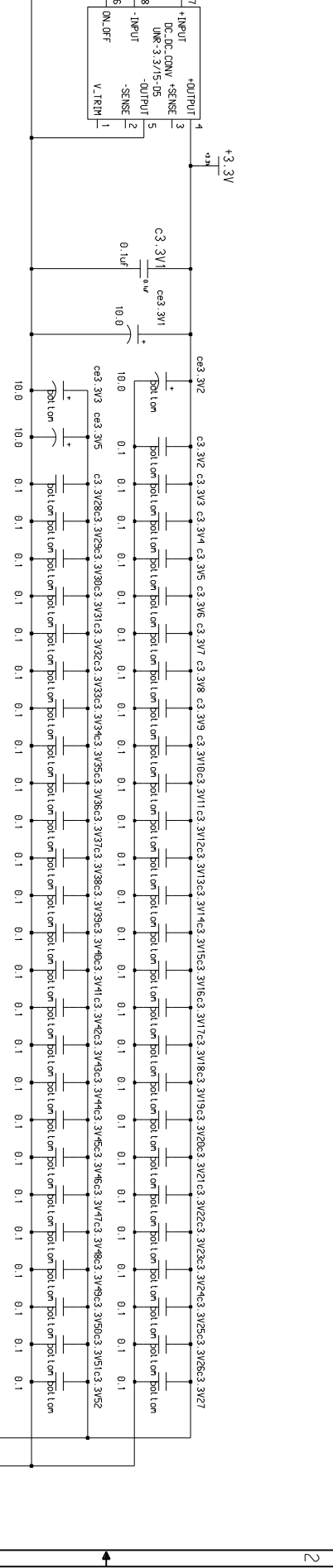
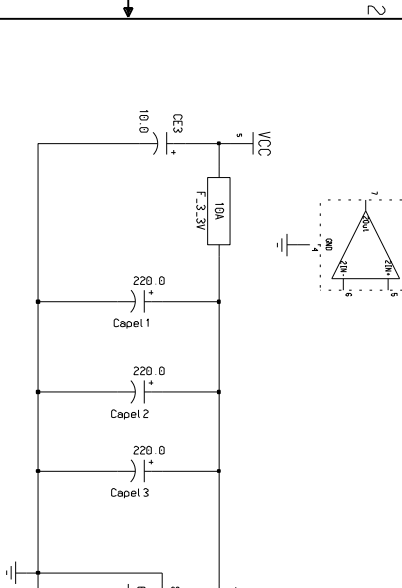
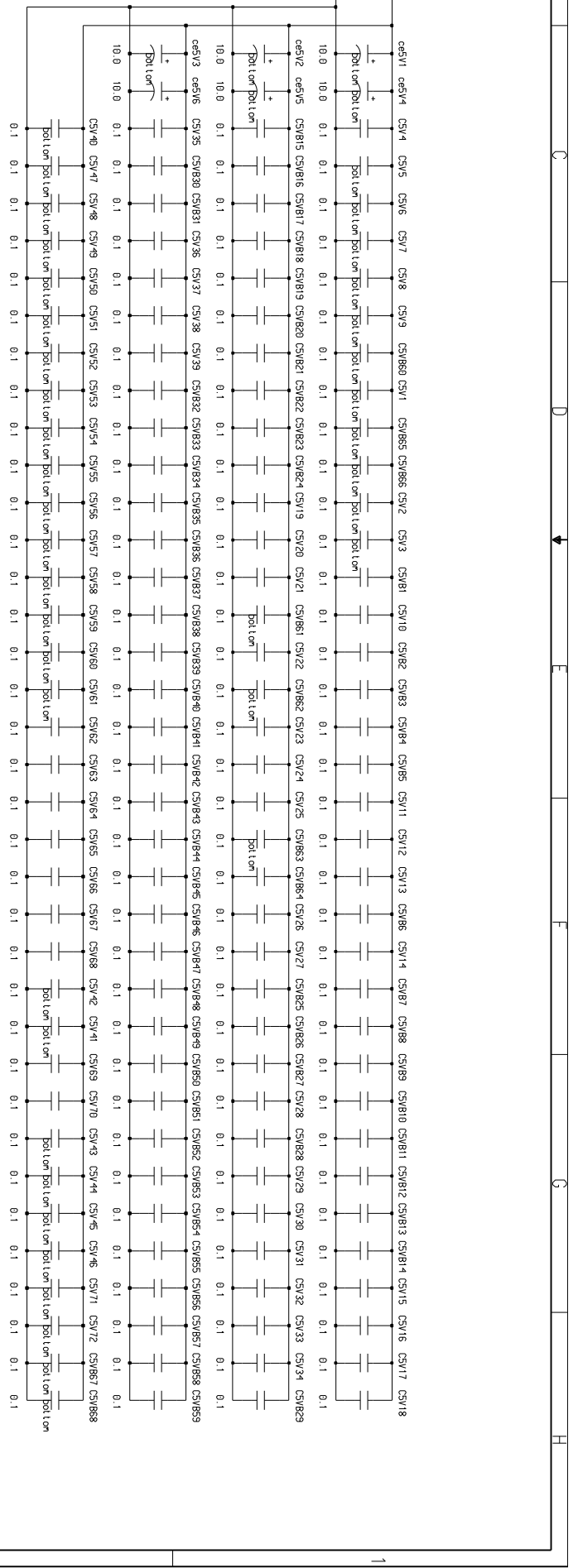
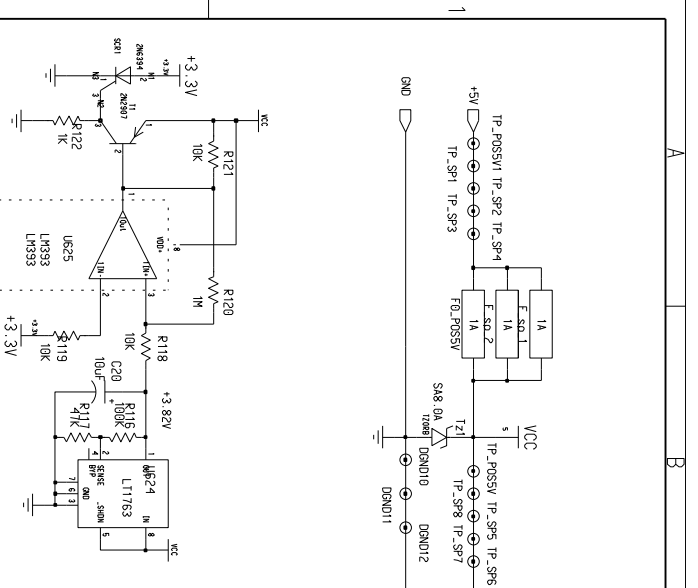

DATE	REVISION	DESCRIPTION

TITLE		Pulsar/ Power	
UNIVERSITY OF CHICAGO			
ELECTRONICS DEVELOPMENT GROUP			
SHEET	18 OF 25	C-2501	
DATE	6/1/02	REV A	
DRN	MBNL		

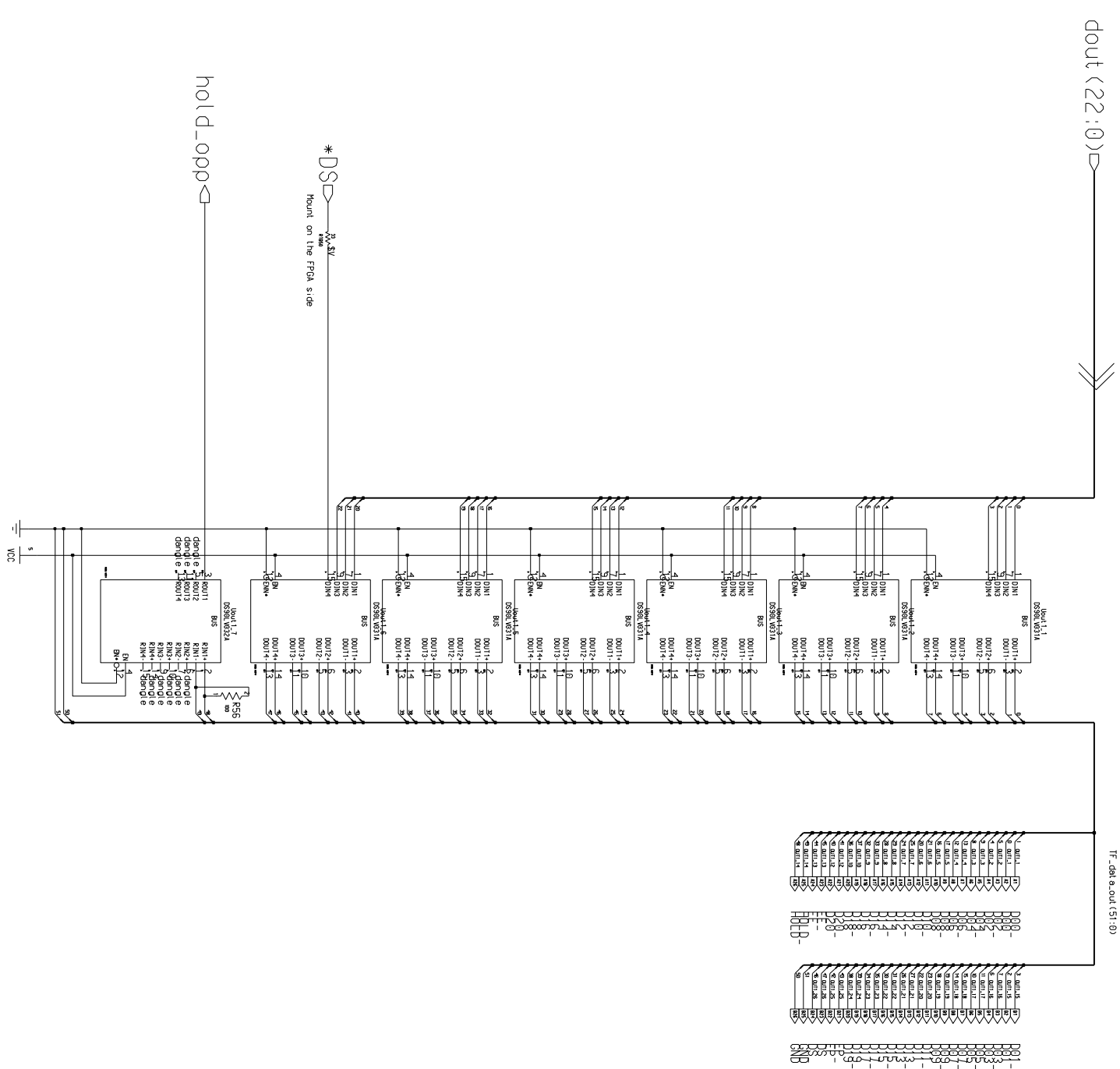

hold_opp

*DS Mount on the PCB side

DATE	REVISION DESCRIPTION

UNIVERSITY OF CHICAGO
ELECTRONICS DEVELOPMENT GROUP

Pulsar
Front_Panel/DATAOUT

SHEET	19 OF 25	C-2501
DATE	01 Feb 1999	REV A
DRN	T. Nakaya	

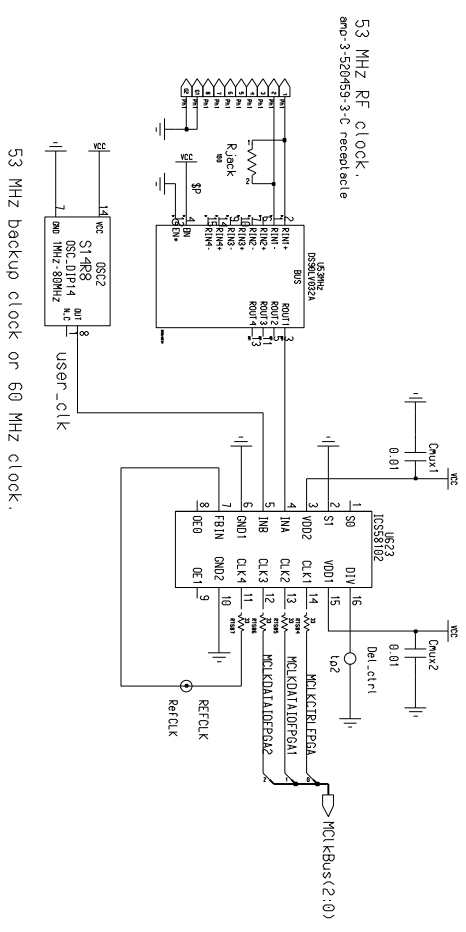
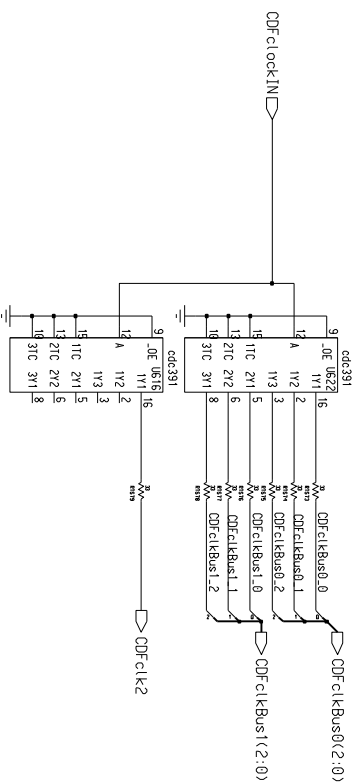
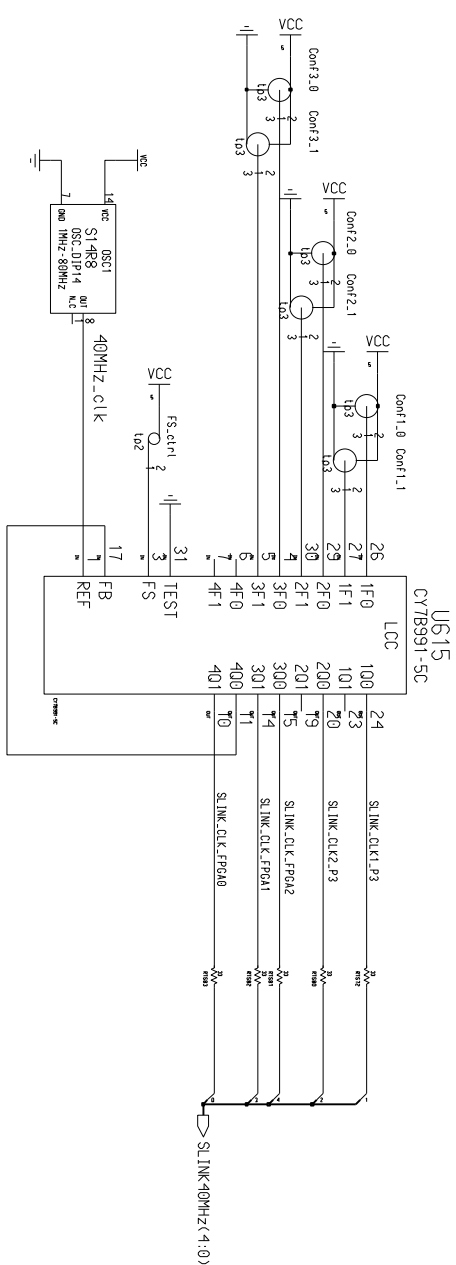

Engineer MB/TL	COMPANY NAME	
Drawn by MB/TL	Address	
R3D CHK	City	
DOC CTRL CHK	TITLE Pulsar: clocks	
MFG CTRL CHK	Size D	
QA CHK	REV	Drawing Number
		Sheet 20 of 25

Changed by Dogdan Date Changed Wednesday, February 27, 2002 Time 1:23:36 pm

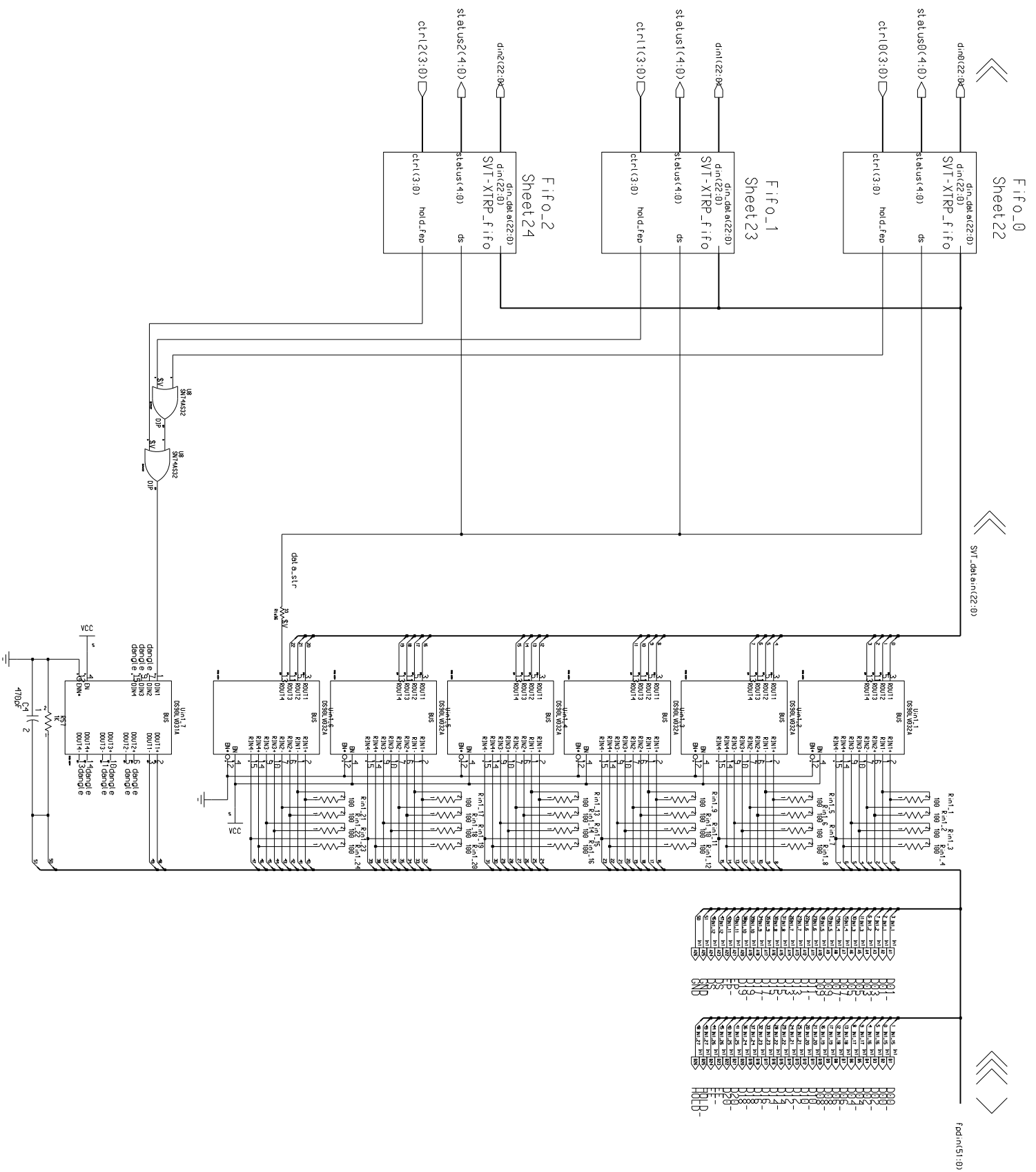

UNIVERSITY OF CHICAGO ELECTRONICS DEVELOPMENT GROUP	
Pulsar Front_Panel/DATAIN	
DATE	REVISION DESCRIPTION
Sheet 21 of 25	
DATE 2002-03-01	C-2501
DRN MB/TL	REV A

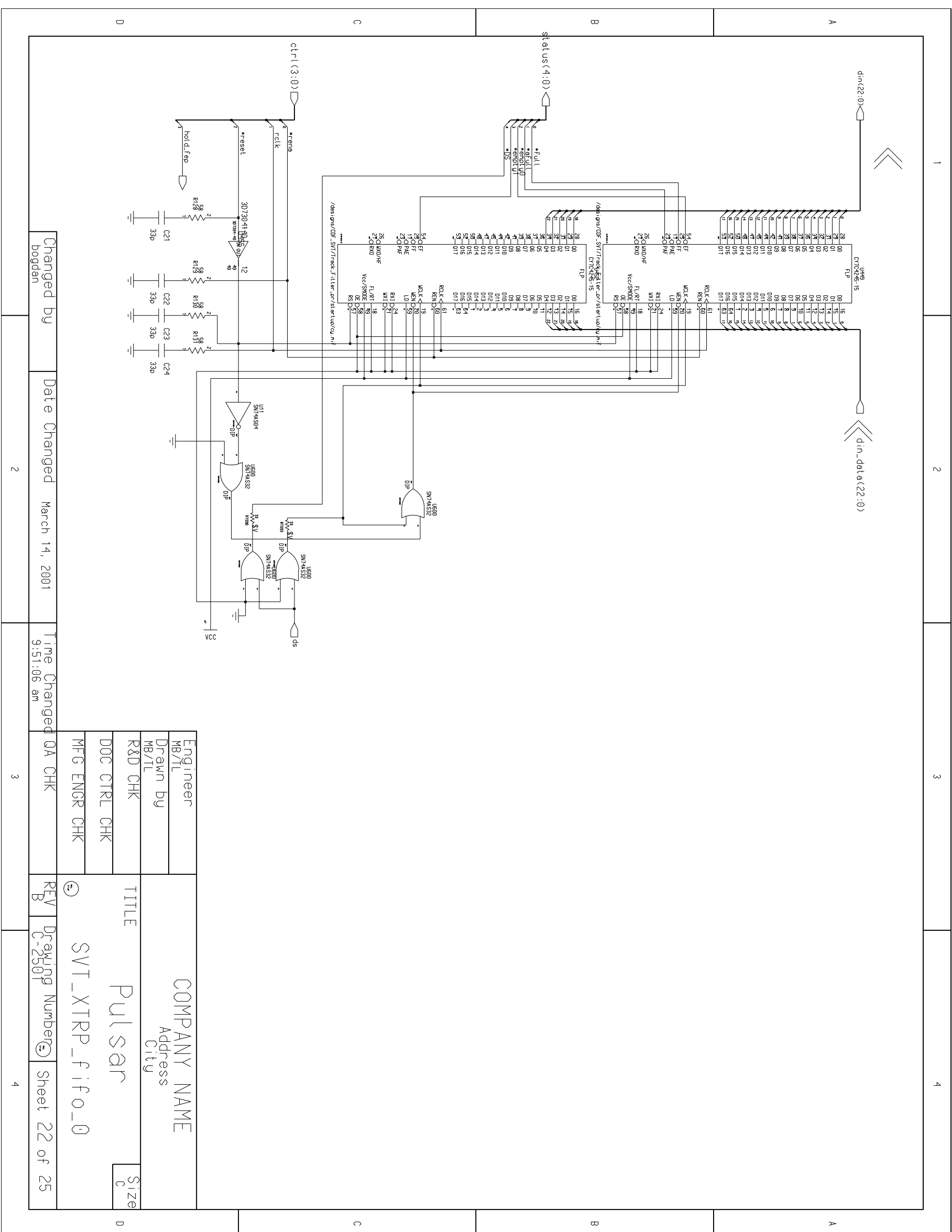

Changed By bogdan

Date Changed March 14, 2001

Time Changed 9:51:06 am

Engineer	MB/TL	COMPANY NAME Address City PULSAR Size C
Drawn by	MB/TL	
R&D CHK		
DOC CTRL CHK		
MFG ENGR CHK		
QA CHK		TITLE
REV B	C-2501	SVT_XTRP_F:FO_0
Drawing Number		Sheet 22 of 25

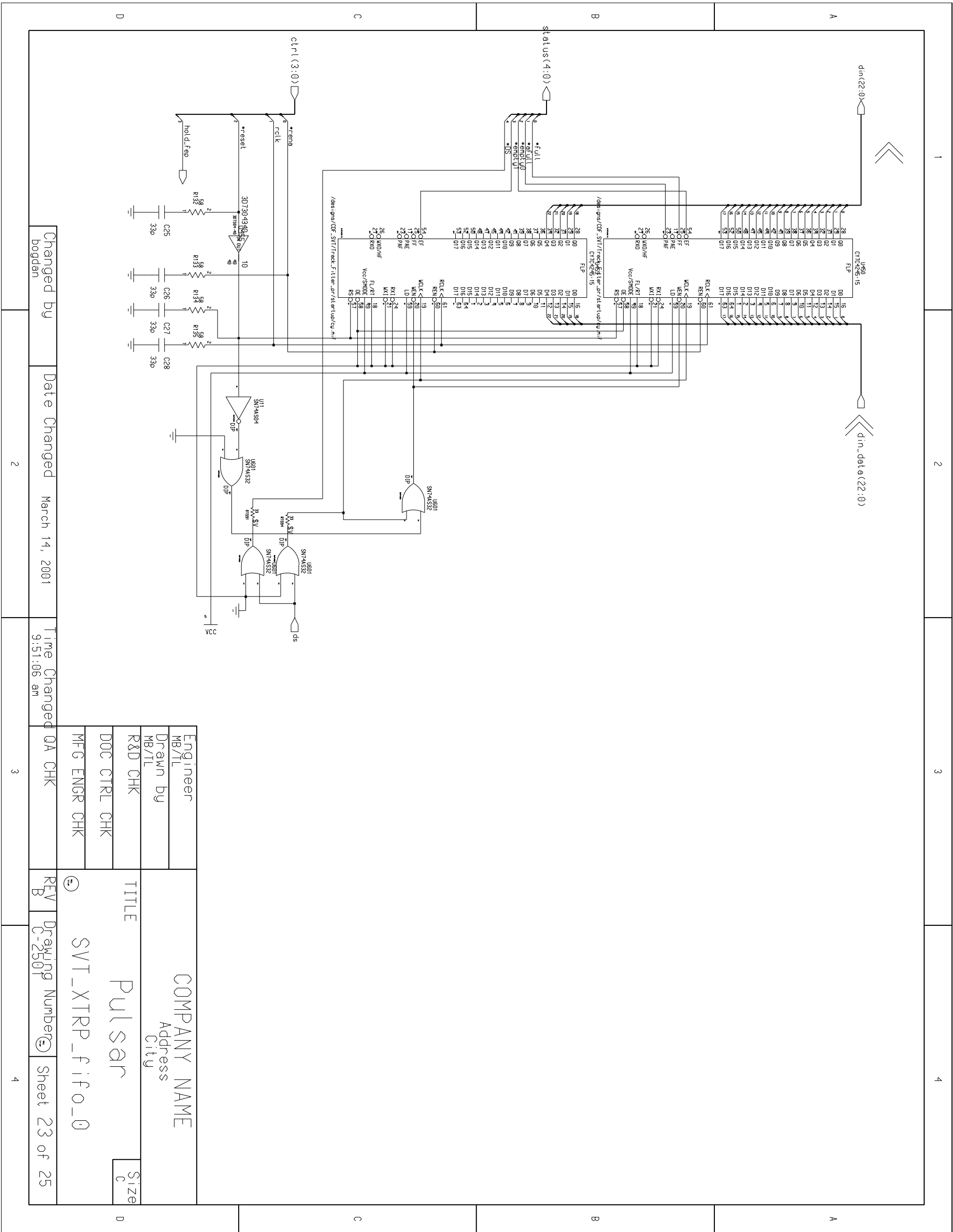

Changed By bogdan

Date Changed March 14, 2001

Time Changed 9:51:06 am

QA CHK

REV B

Drawing Number C-2501

Sheet 23 of 25

Engineer	COMPANY NAME Address City	TITLE Pulsar	Size C
Drawn by			
R&D CHK			
DOC CTRL CHK			
MFG ENGR CHK	SVT_XTRP_F:FO_0		

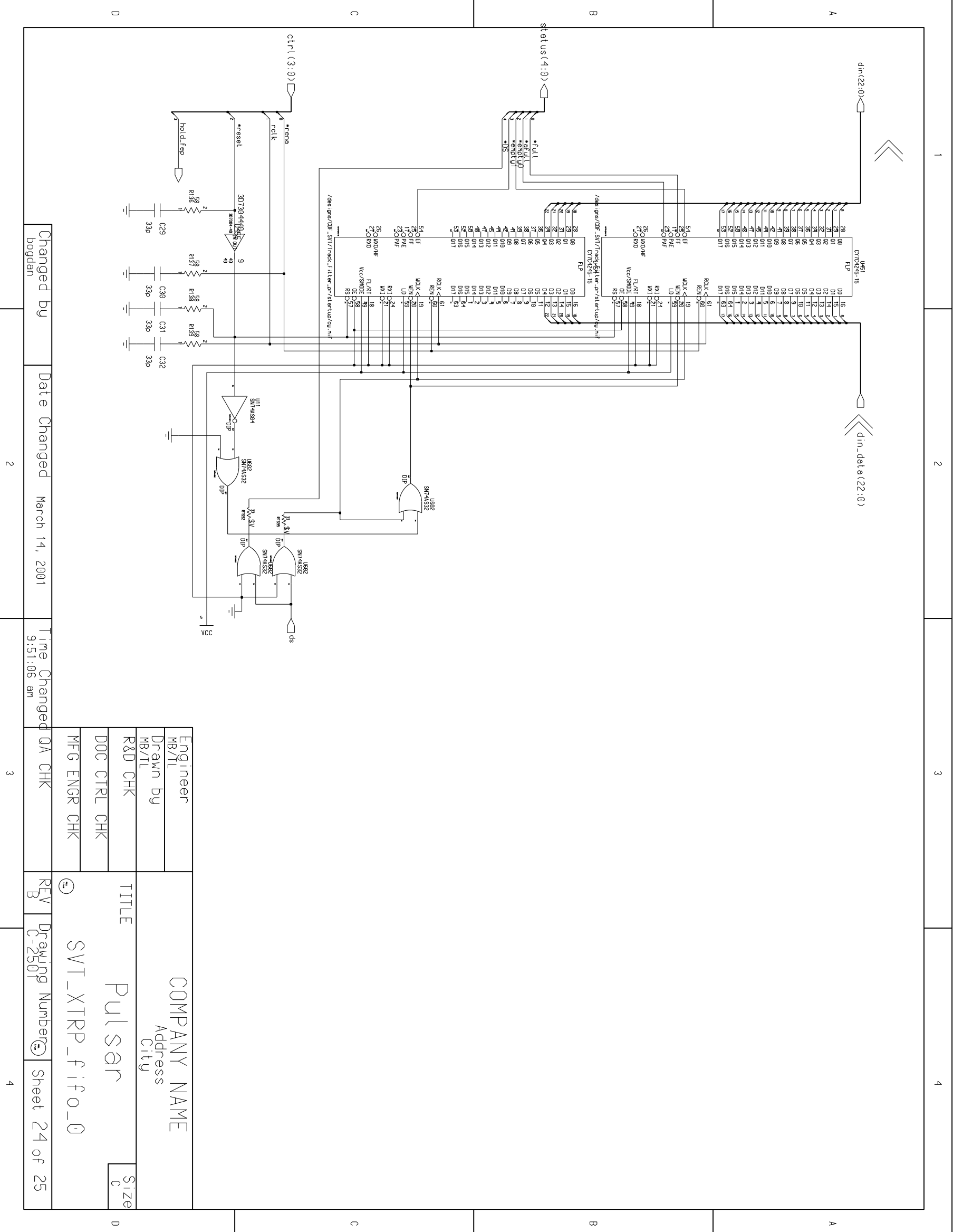

Changed by bogdan

Date Changed March 14, 2001

Time Changed 9:51:06 am

QA CHK

RFV B

Drawing Number C-2501

Sheet 24 of 25

Engineer	MB/TL	COMPANY NAME	Size
Drawn by	MB/TL	Address	C
R&D CHK		City	
DOC CTRL CHK			
MFG ENGR CHK			
TITLE	Pulsar		
	SVT_XTRP_fifo_0		

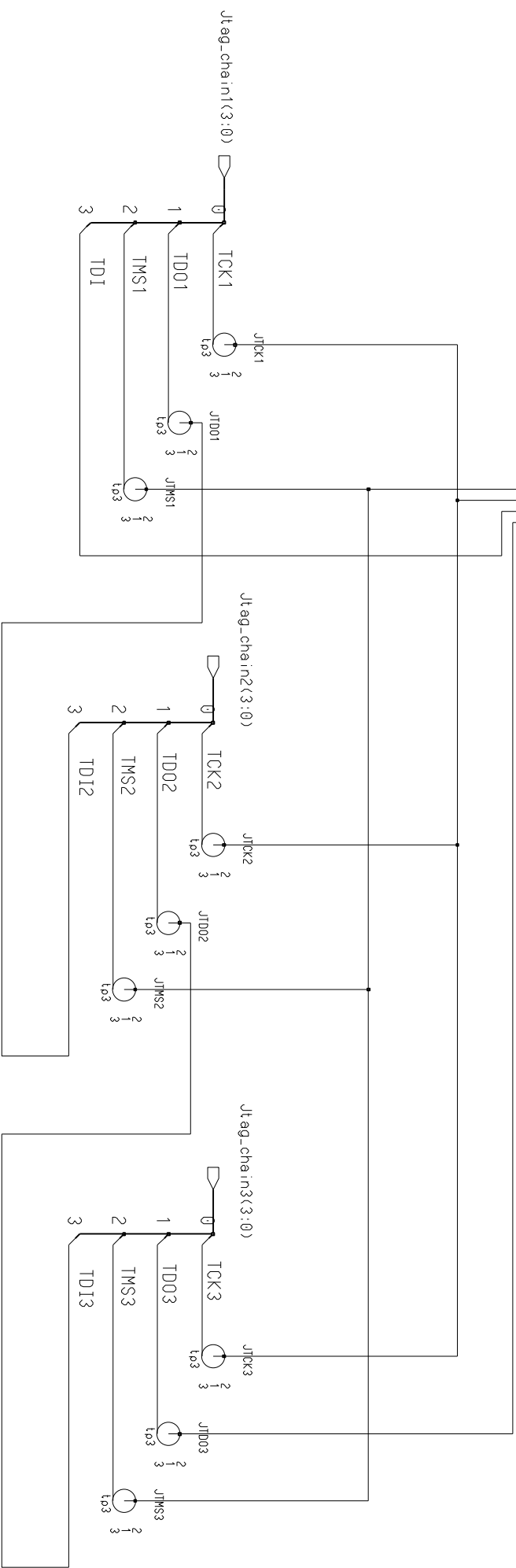
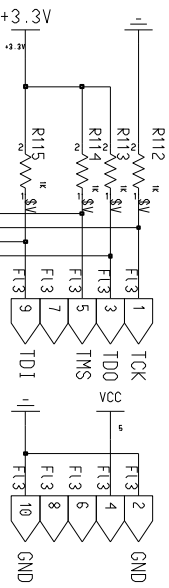

DATE	REVISION DESCRIPTION

UNIVERSITY OF CHICAGO
 ELECTRONICS DEVELOPMENT GROUP

TITLE
 Pulsar
 Jtag_Chain

SHEET 25 OF 25
 DATE 6/14/2002
 DRWN MB/TL

C-2501
 REV A

