

$$V_o = V_r + (V_p - V_n) * R_f / R$$

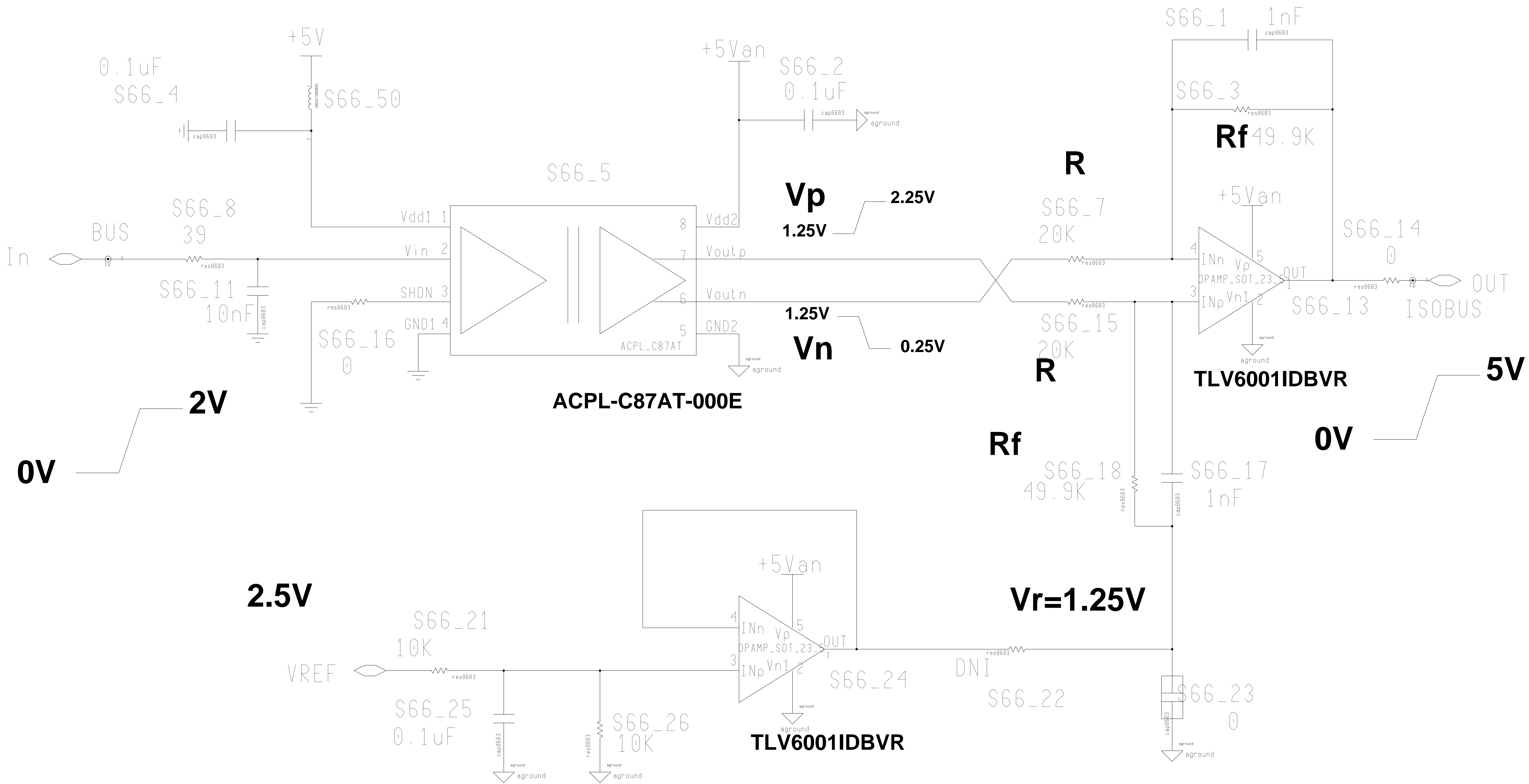

SCH-2976
 SPC-2977
 ASM-2978

Engineer: M. Bogdan	The University of Chicago HELIX Monitor Board Isolated Amplifier - PVA 1	
Drawn by: M. Bogdan		
DATE: 7/29/2021		
REV. A	DRW. 2976	Sheet 6_6