

Artwork_1: TOP

TFM Card
10/3/2019
Mircea Bogdan
Electronics Design Group
University Of Chicago
Sch. Draw 2937-A
Spc. Draw 2938-A
Asy. Draw 2939-A

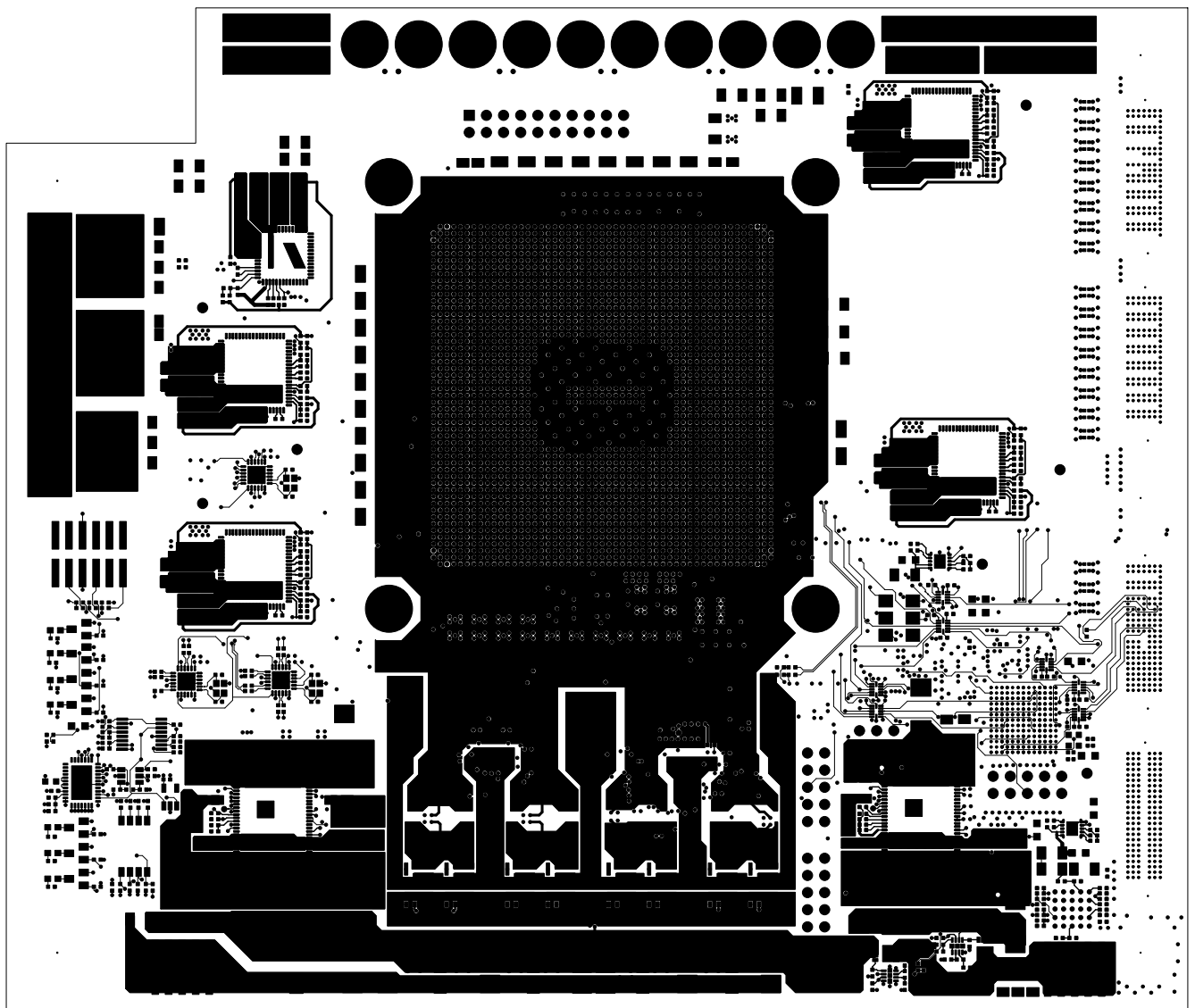

Artwork_2: GROUND, GND_SIGNAL_CORE

TFM Card
10/3/2019
Mircea Bogdan
Electronics Design Group
University Of Chicago
Sch. Draw 2937-A
Spc. Draw 2938-A
Asy. Draw 2939-A

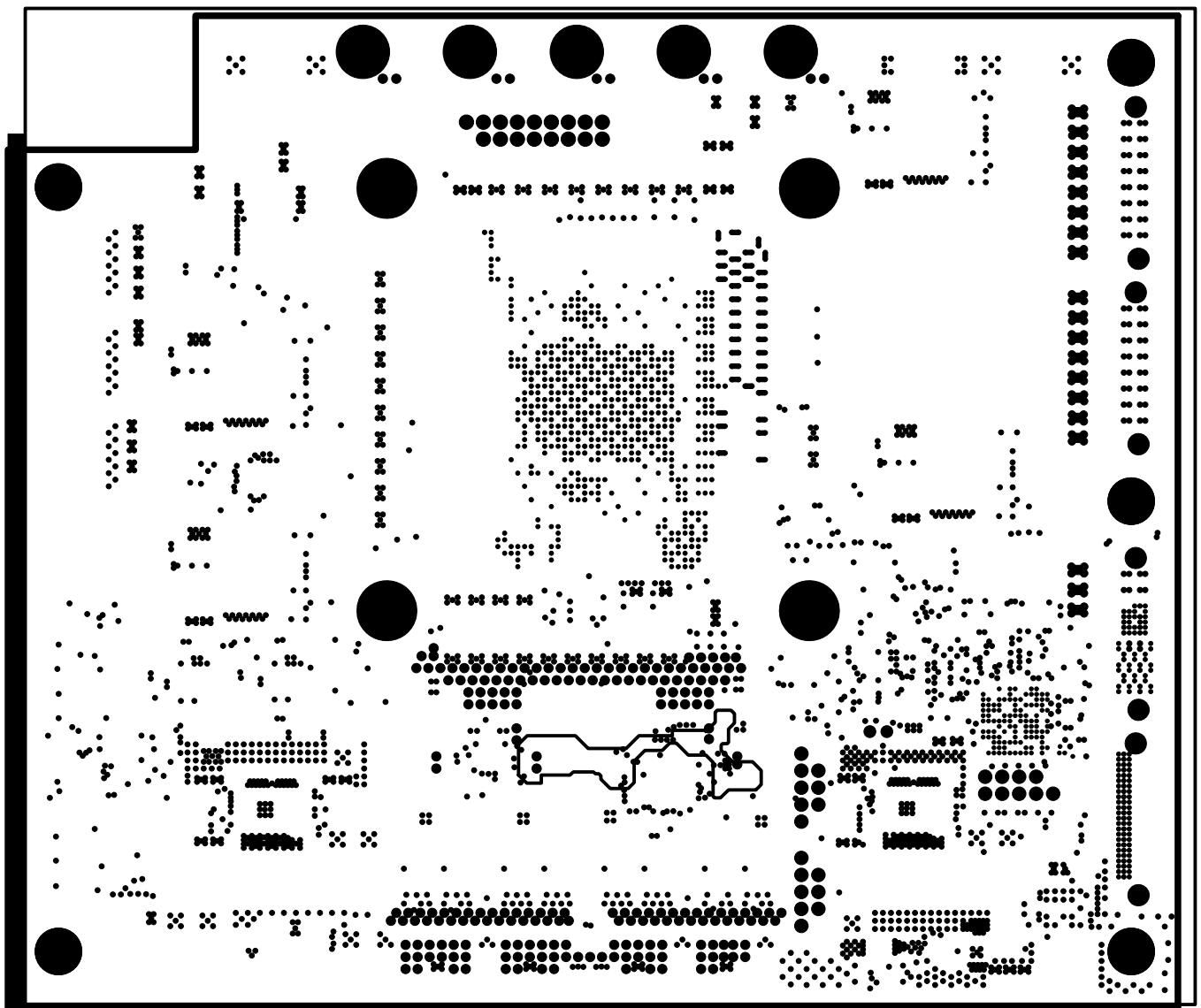

Artwork_3: SIGNAL

TFM Card
10/3/2019
Mircea Bogdan
Electronics Design Group
University Of Chicago
Sch. Draw 2937-A
Spc. Draw 2938-A
Asy. Draw 2939-A

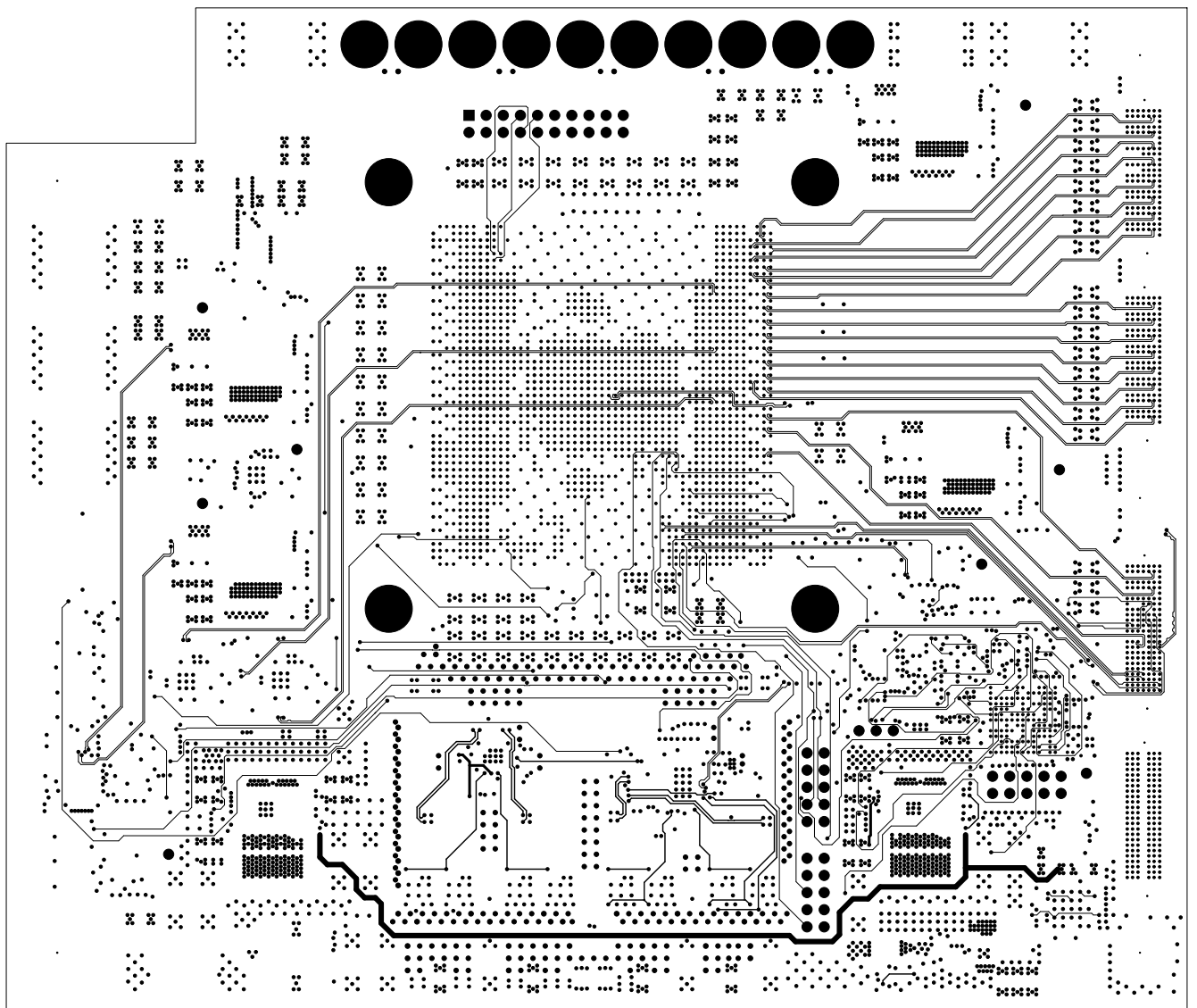

Artwork_4: GROUND, 5V

TFM Card
10/3/2019
Mircea Bogdan
Electronics Design Group
University Of Chicago
Sch. Draw 2937-A
Spc. Draw 2938-A
Asy. Draw 2939-A

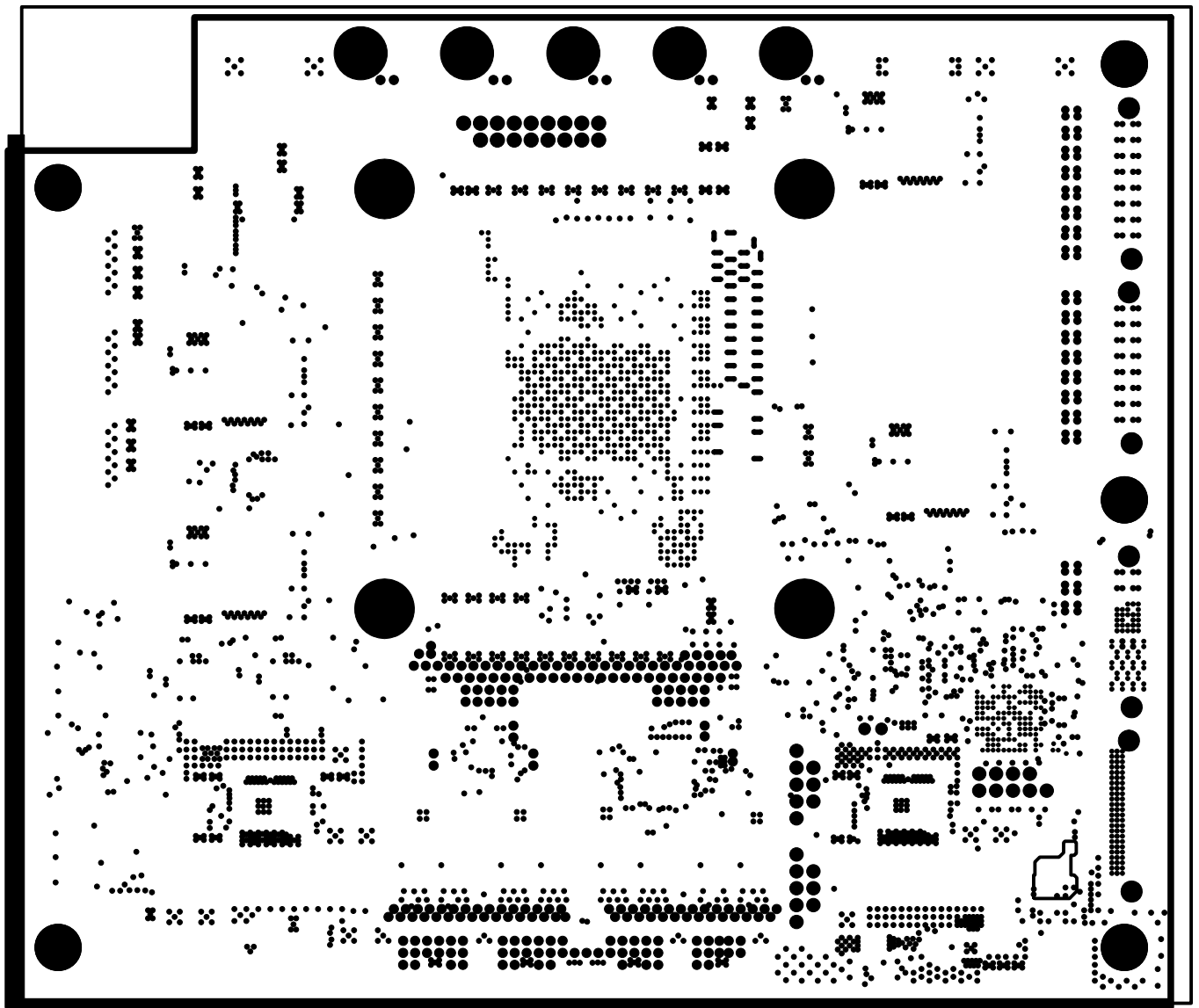

Artwork_5: POWER: VCC, 12V_G1, 12V_G2, 12Vin, VIN1, MAX10_AGND

TFM Card
10/3/2019
Mircea Bogdan
Electronics Design Group
University Of Chicago
Sch: Draw 2937-A
SpC: Draw 2938-A
Asy: Draw 2939-A

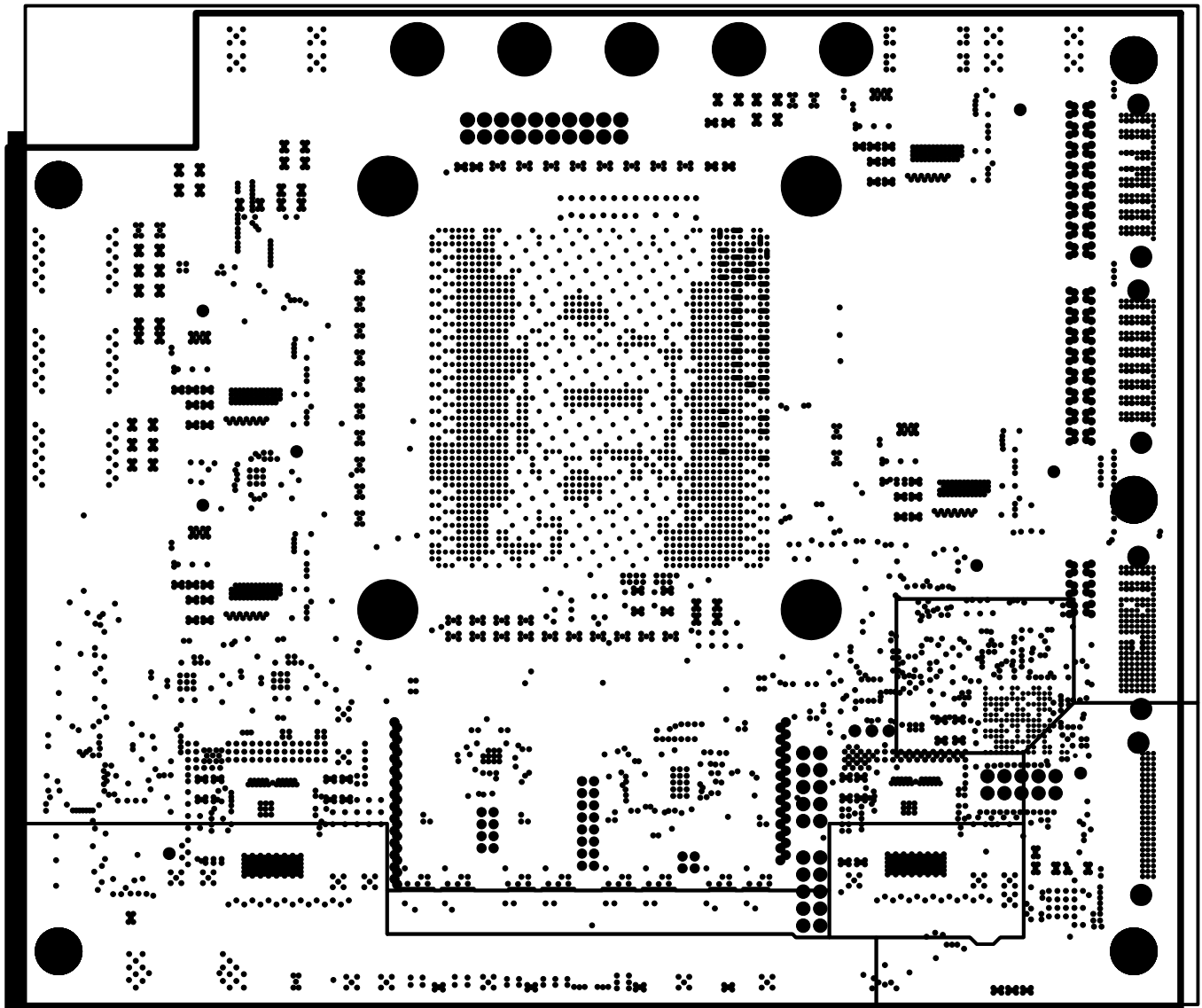

Artwork_6: POWER: VCC,12V_G1,12V_G2,12Vin,VIN1

TFM Card
10/3/2019
Mircea Bogdan
Electronics Design Group
University Of Chicago
Sch: Draw 2937-A
SpC: Draw 2938-A
Asy: Draw 2939-A

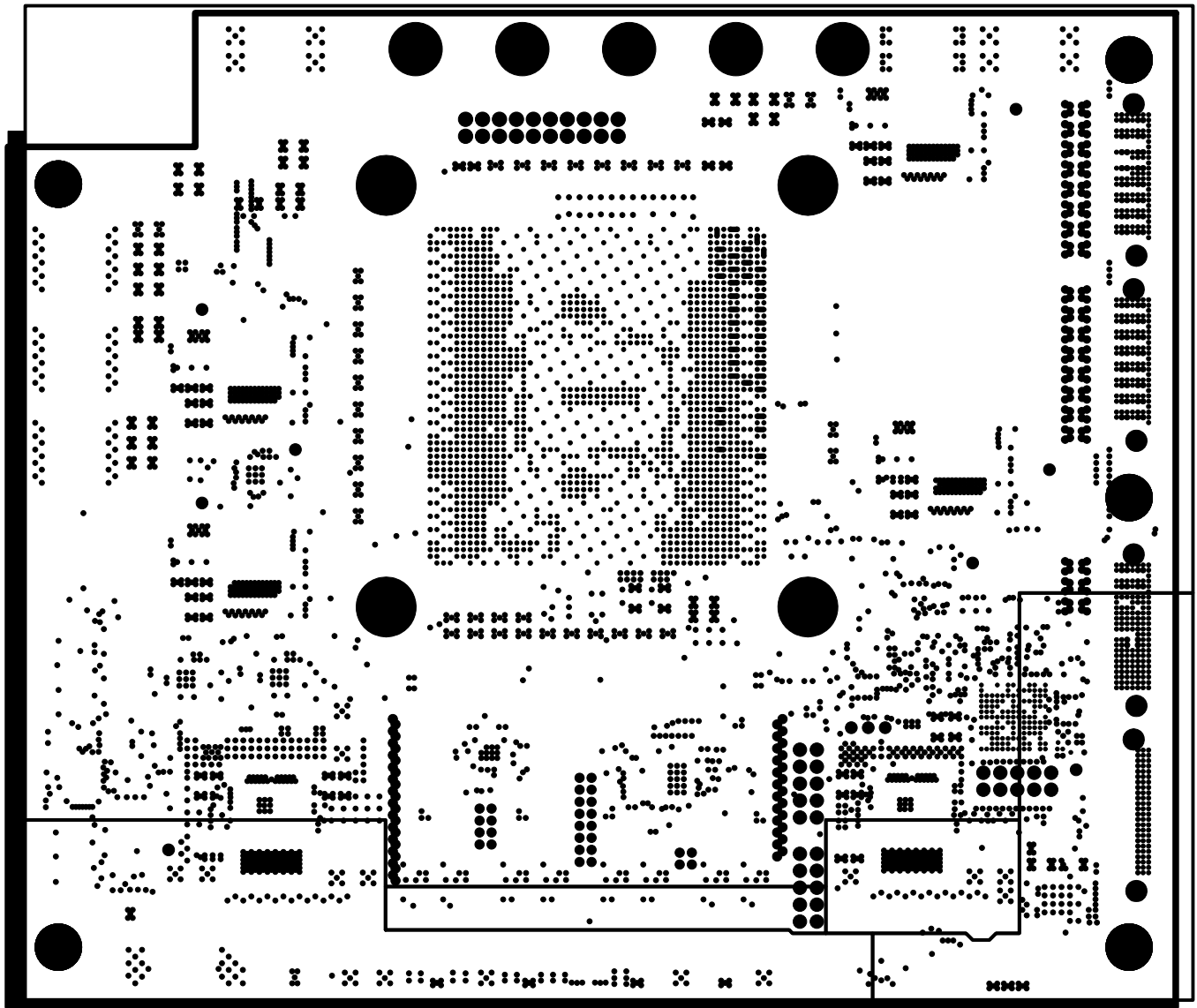

Artwork_7: SIGNAL

TFM Card
10/3/2019
Mircea Bogdan
Electronics Design Group
University Of Chicago
Sch. Draw 2937-A
Spc. Draw 2938-A
Asy. Draw 2939-A

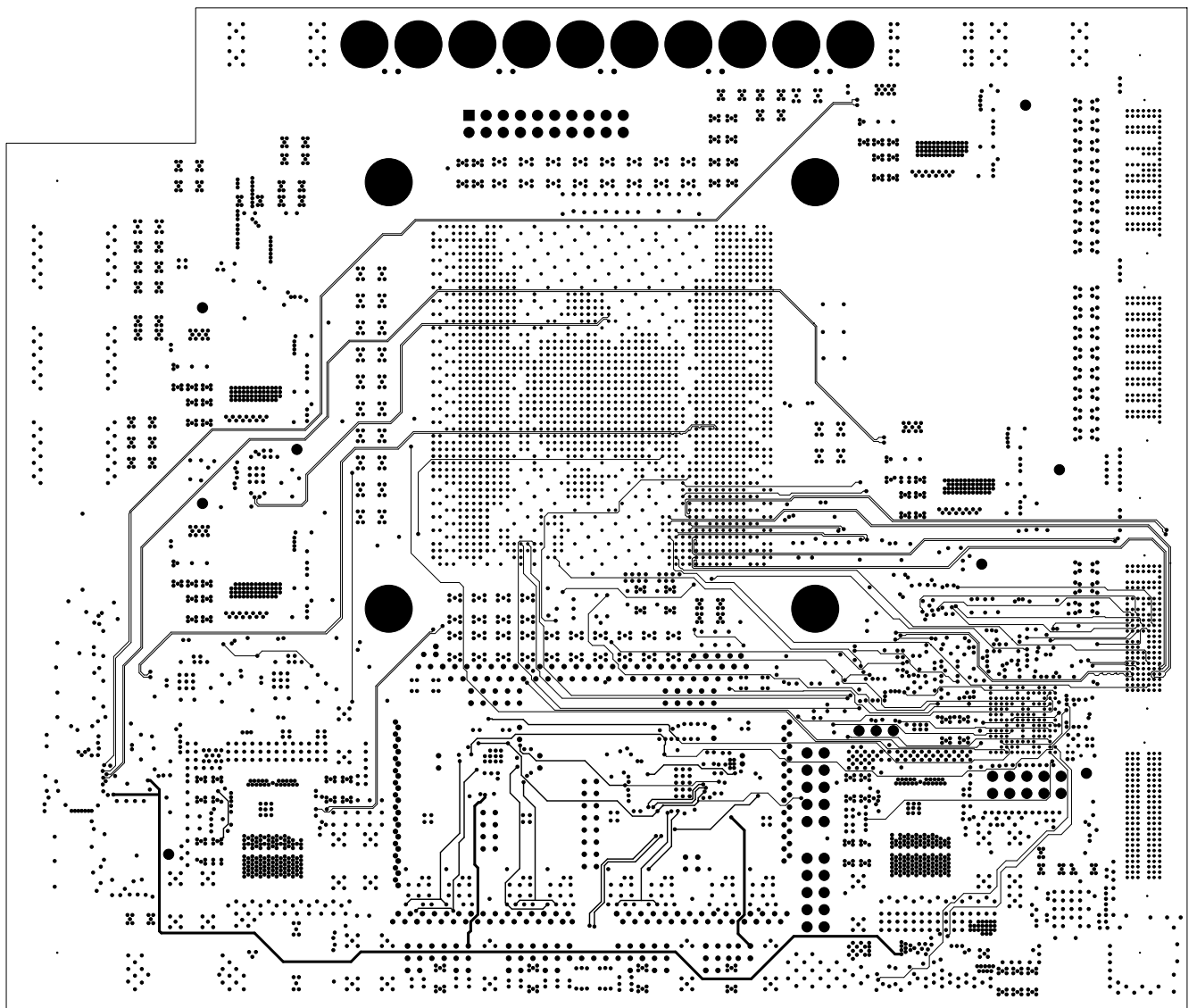

Artwork_8: POWER: 1V8,12V_G1,12V_G2,12Vin,VIN1,VCCT

TFM Card
10/3/2019
Mircea Bogdan
Electronics Design Group
University Of Chicago
Sch: Draw 2937-A
Spc: Draw 2938-A
Asy: Draw 2939-A

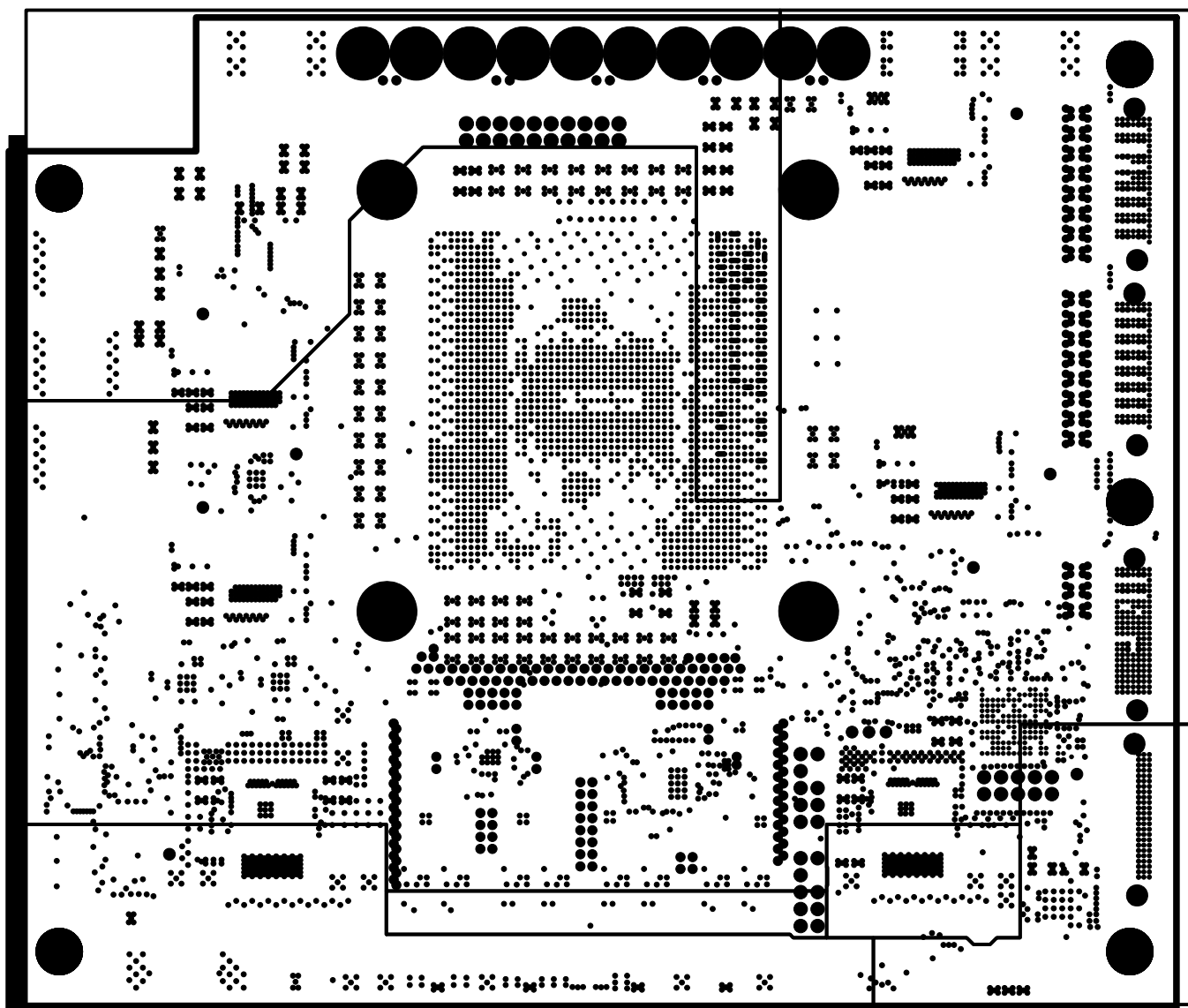

Artwork_9: POWER: VCC10_UIB,12V_G1,12V_G2,12Vin,VIN1,VCCERAM

TFM Card
10/3/2019
Mircea Bogdan
Electronics Design Group
University Of Chicago
Sch: Draw 2937-A
SpC: Draw 2938-A
Asy: Draw 2939-A

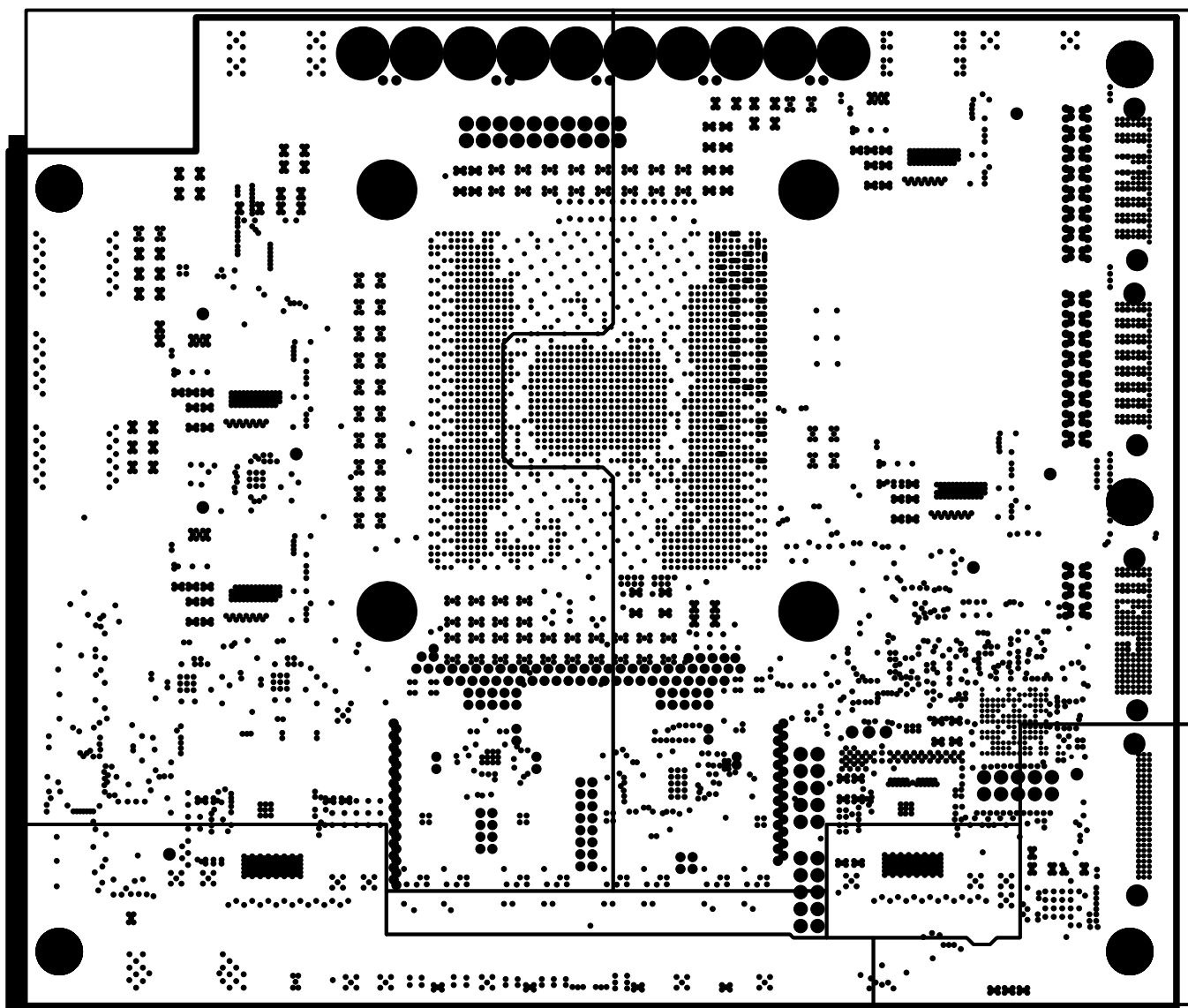

Artwork_10: SIGNAL

TFM Card
10/3/2019
Mircea Bogdan
Electronics Design Group
University Of Chicago
Sch: Draw 2937-A
Spc: Draw 2938-A
Asy: Draw 2939-A

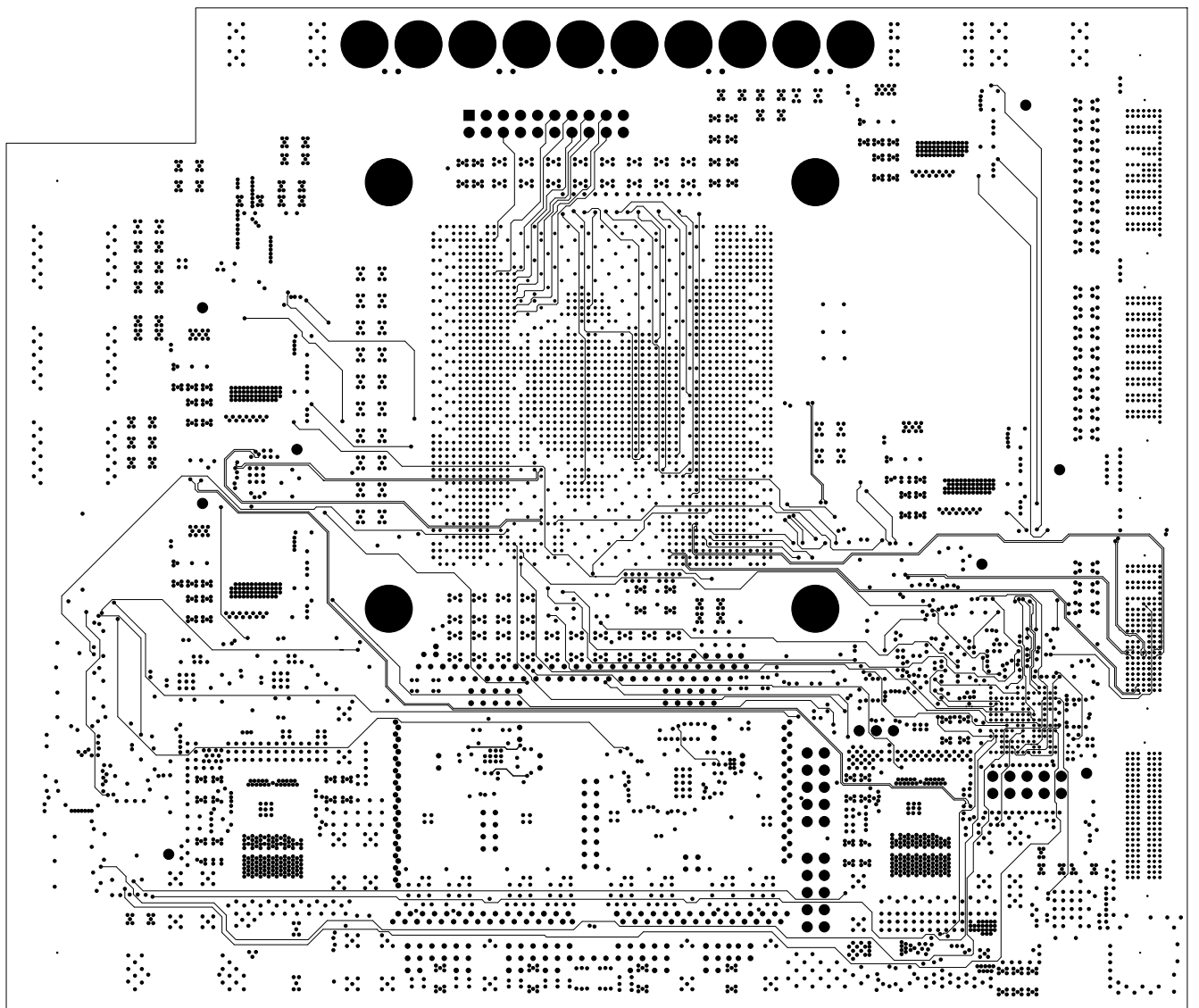

Artwork_11: POWER: 3V3,3V3_STBY,VCCM,VCCRL

TFM Card
10/3/2019
Mircea Bogdan
Electronics Design Group
University Of Chicago
Sch: Draw 2937-A
Spc: Draw 2938-A
Asy: Draw 2939-A

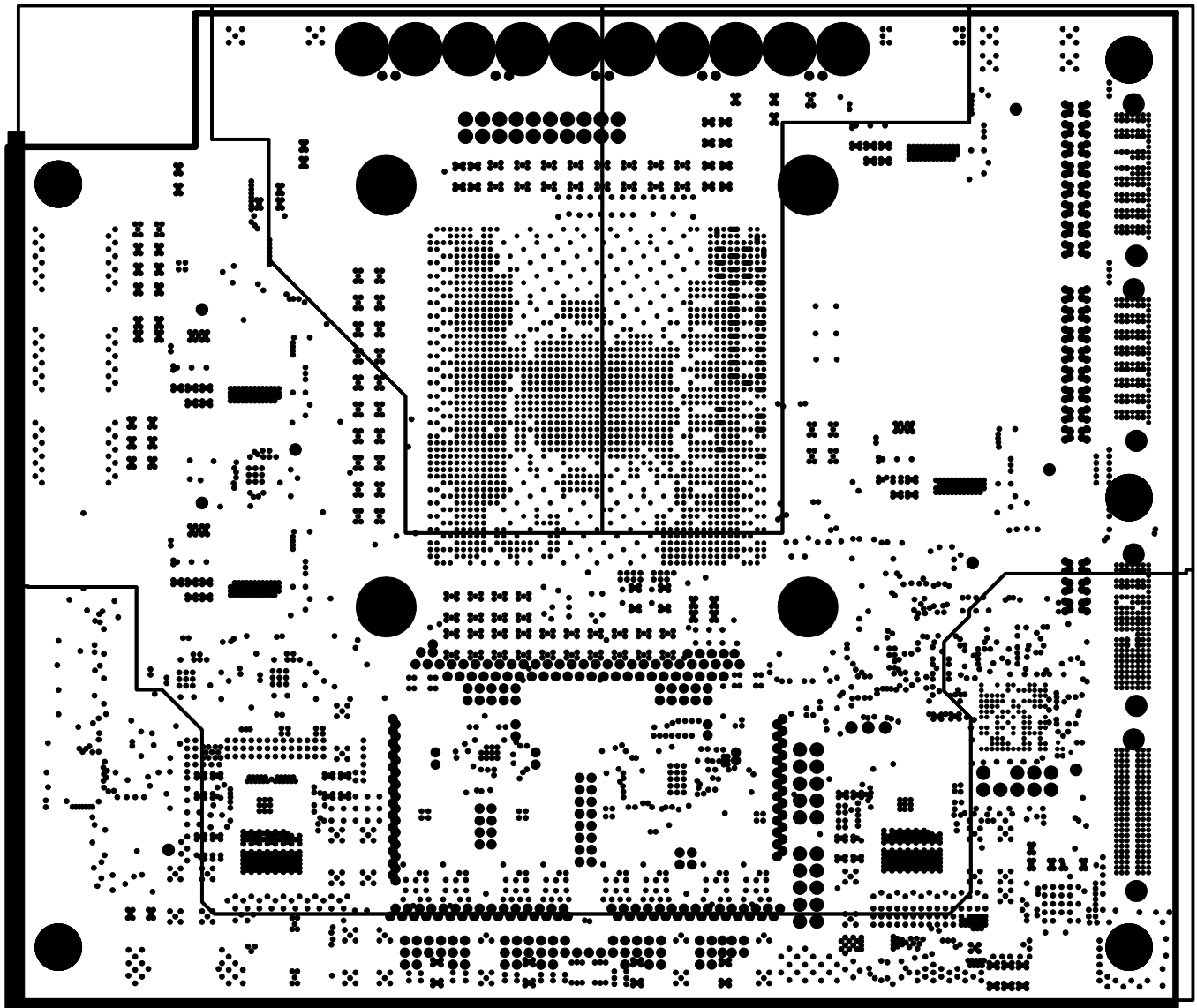

Artwork_12: POWER: 3V3,PWR_M10_VCCA,1V8_FLTR,VCCPLLDIG,VCCPLL

TFM Card
10/3/2019
Mircea Bogdan
Electronics Design Group
University Of Chicago
Sch: Draw 2937-A
Spc: Draw 2938-A
Asy: Draw 2939-A

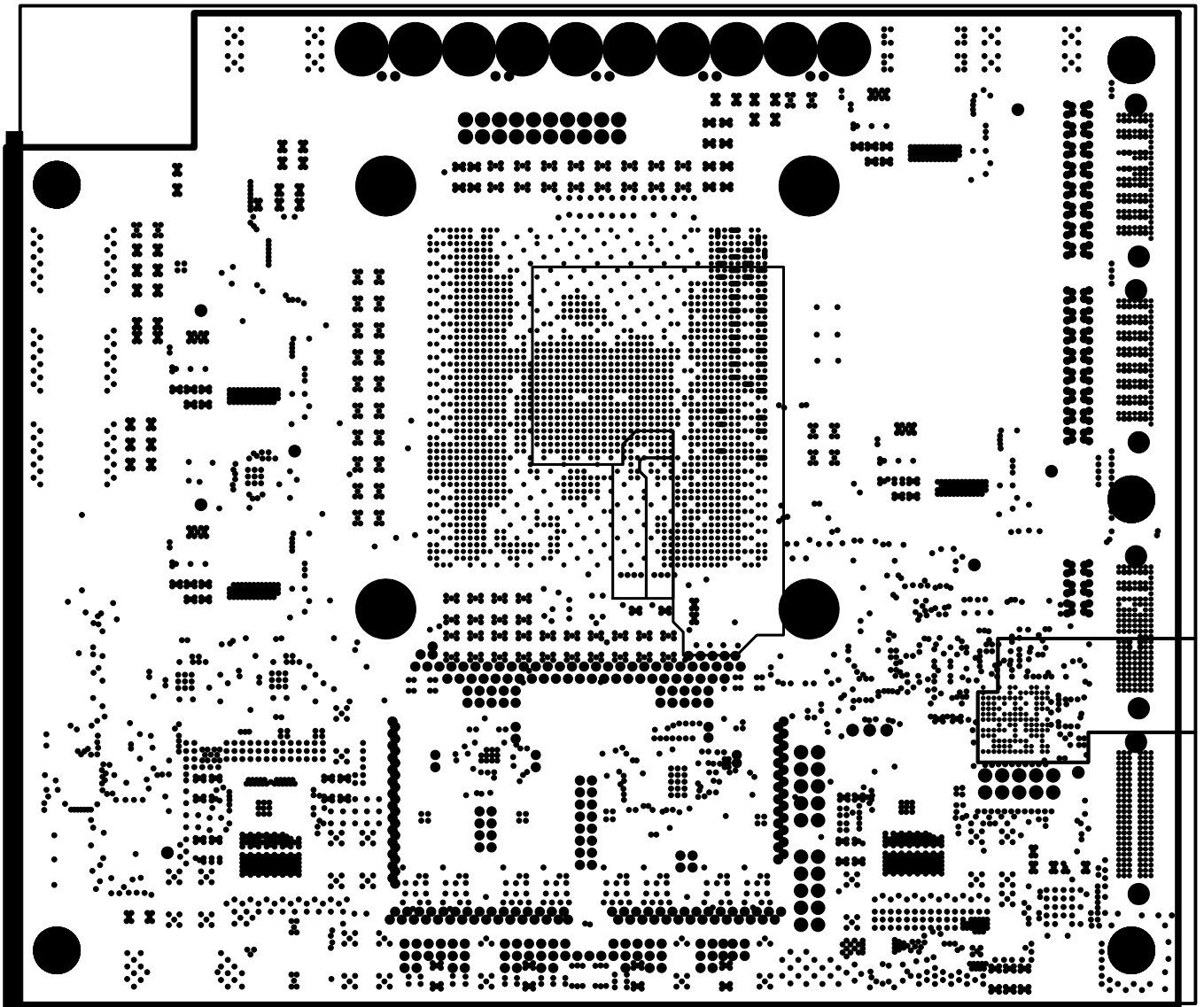

Artwork_13: GROUND, 1V8_S15338_1,1V8_S15338_2,1V8_S15338_3

TFM Card
10/3/2019
Mircea Bogdan
Electronics Design Group
University Of Chicago
Sch. Draw 2937-A
Spc. Draw 2938-A
Asy. Draw 2939-A

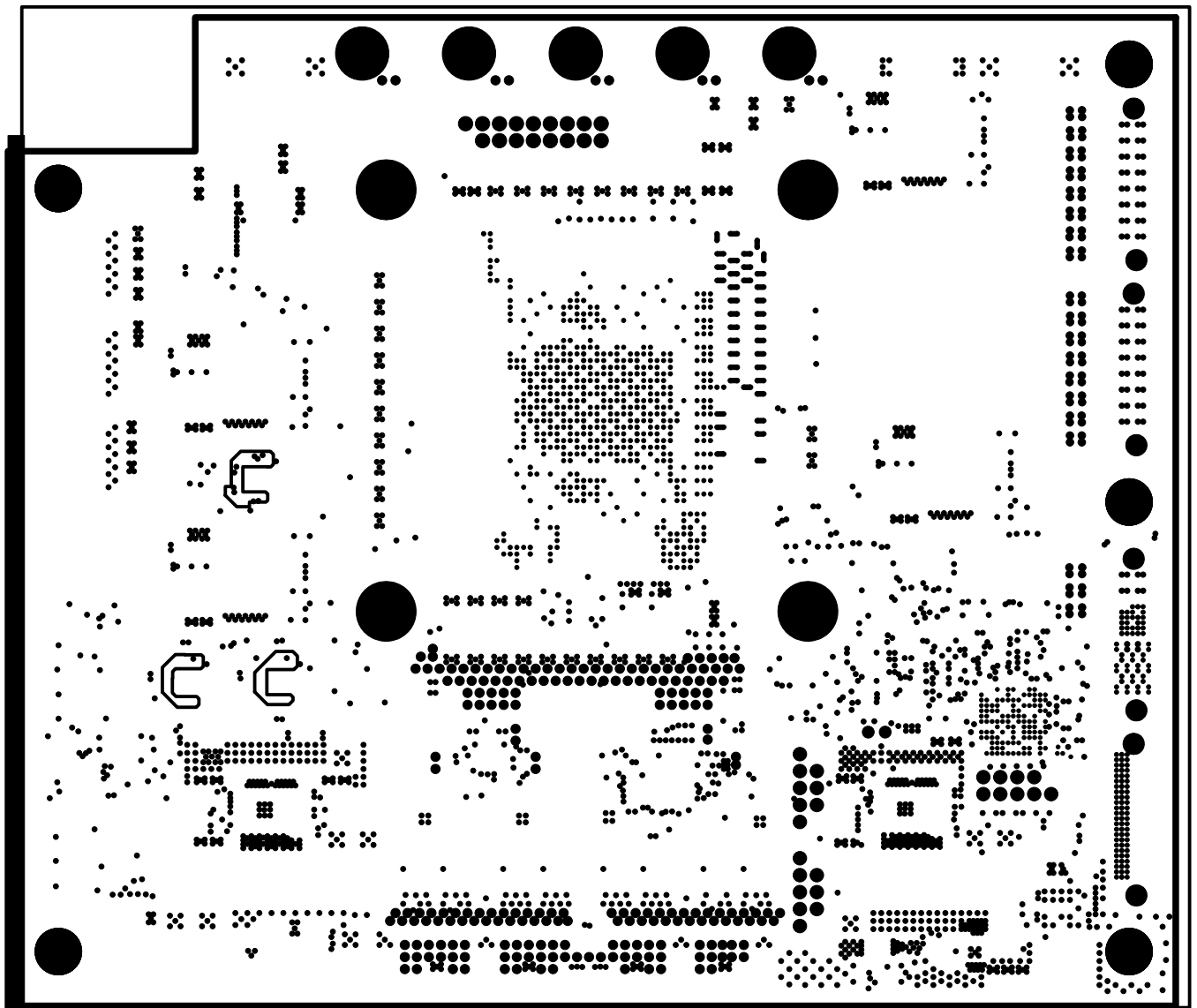

Artwork_14: SIGNAL

TFM Card
10/3/2019
Mircea Bogdan
Electronics Design Group
University Of Chicago
Sch. Draw 2937-A
Spc. Draw 2938-A
Asy. Draw 2939-A

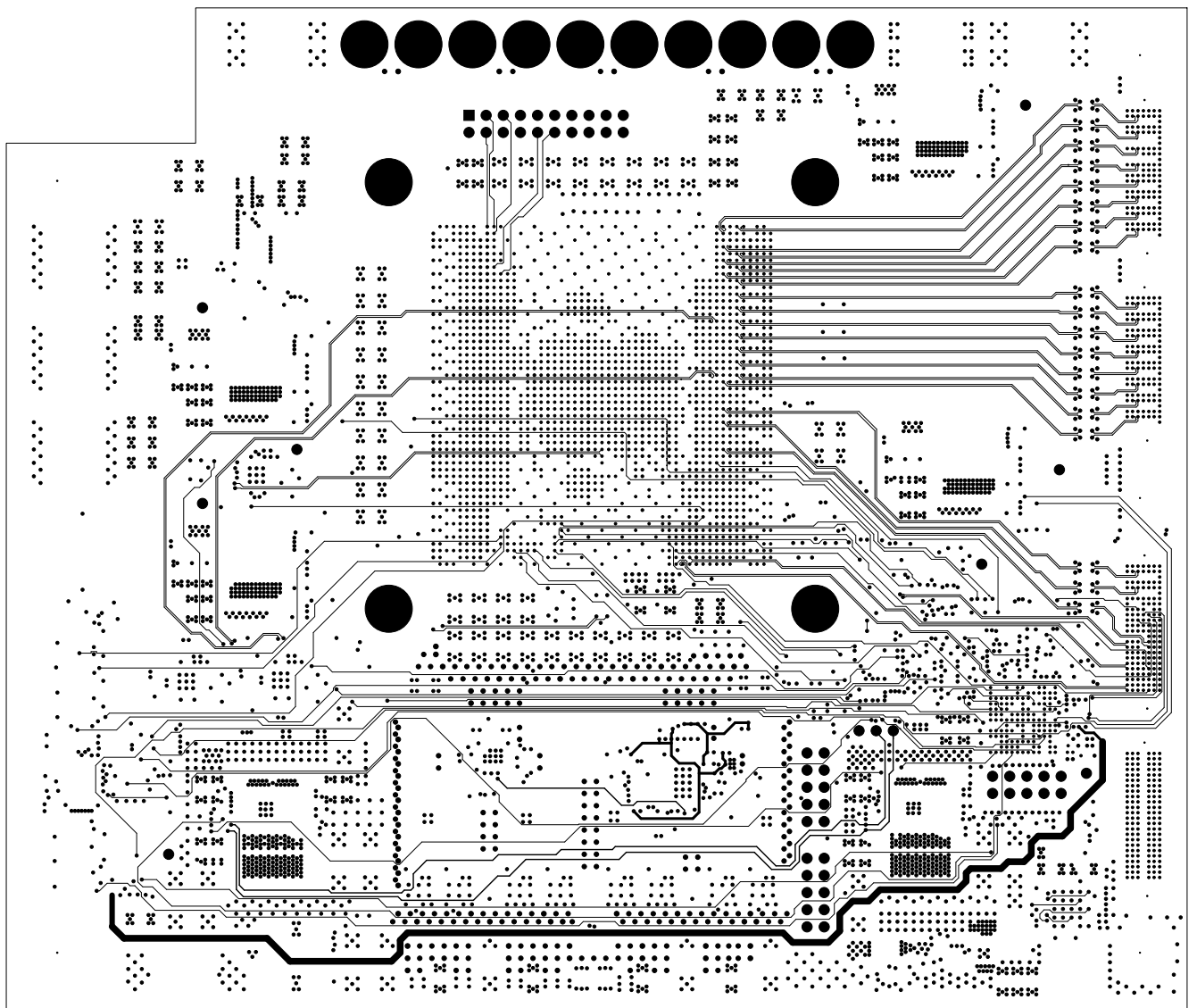

Artwork_15: GROUND, 5V_AGND

TFM Card
10/3/2019
Mircea Bogdan
Electronics Design Group
University Of Chicago
Sch. Draw 2937-A
Spc. Draw 2938-A
Asy. Draw 2939-A

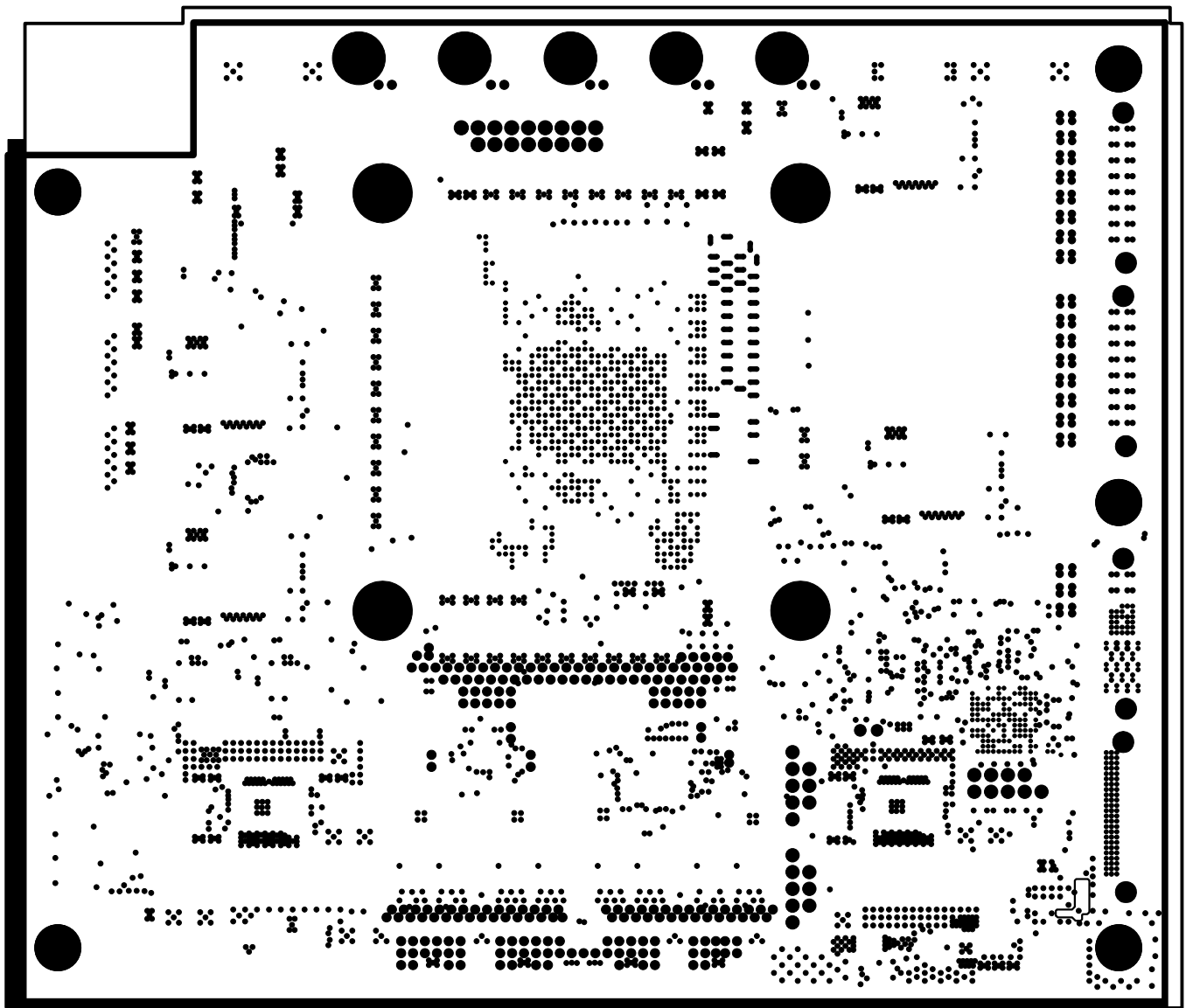

Artwork_16: BOTTOM

TFM Card
10/3/2019
Mircea Bogdan
Electronics Design Group
University Of Chicago
Sch. Draw 2937-A
Spc. Draw 2938-A
Asy. Draw 2939-A

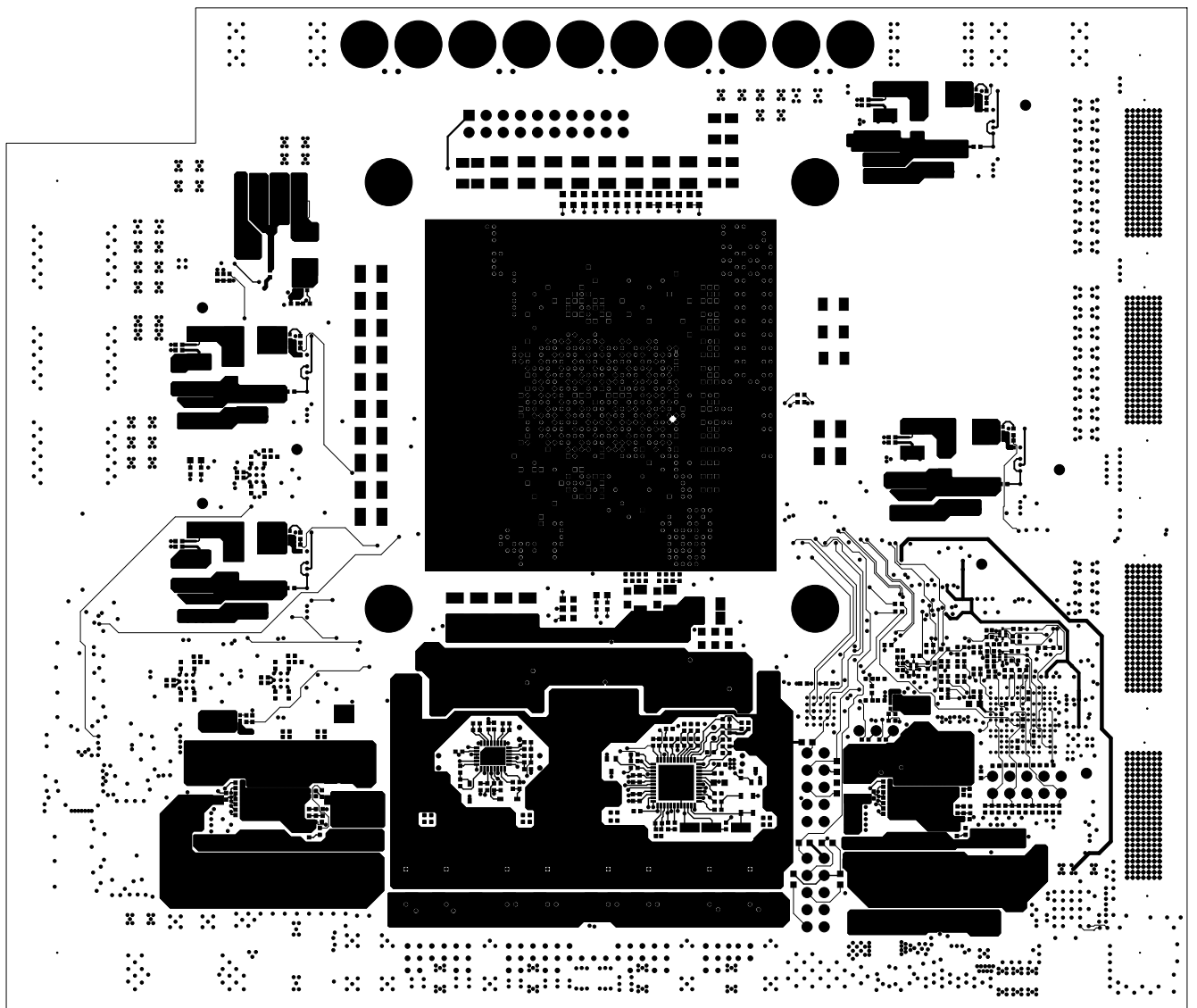

Artwork_17: Top Silkscreen

TFM Card
10/3/2019
Mircea Bogdan
Electronics Design Group
University Of Chicago
Sch. Draw 2937-A
Spc. Draw 2938-A
Asy. Draw 2939-A

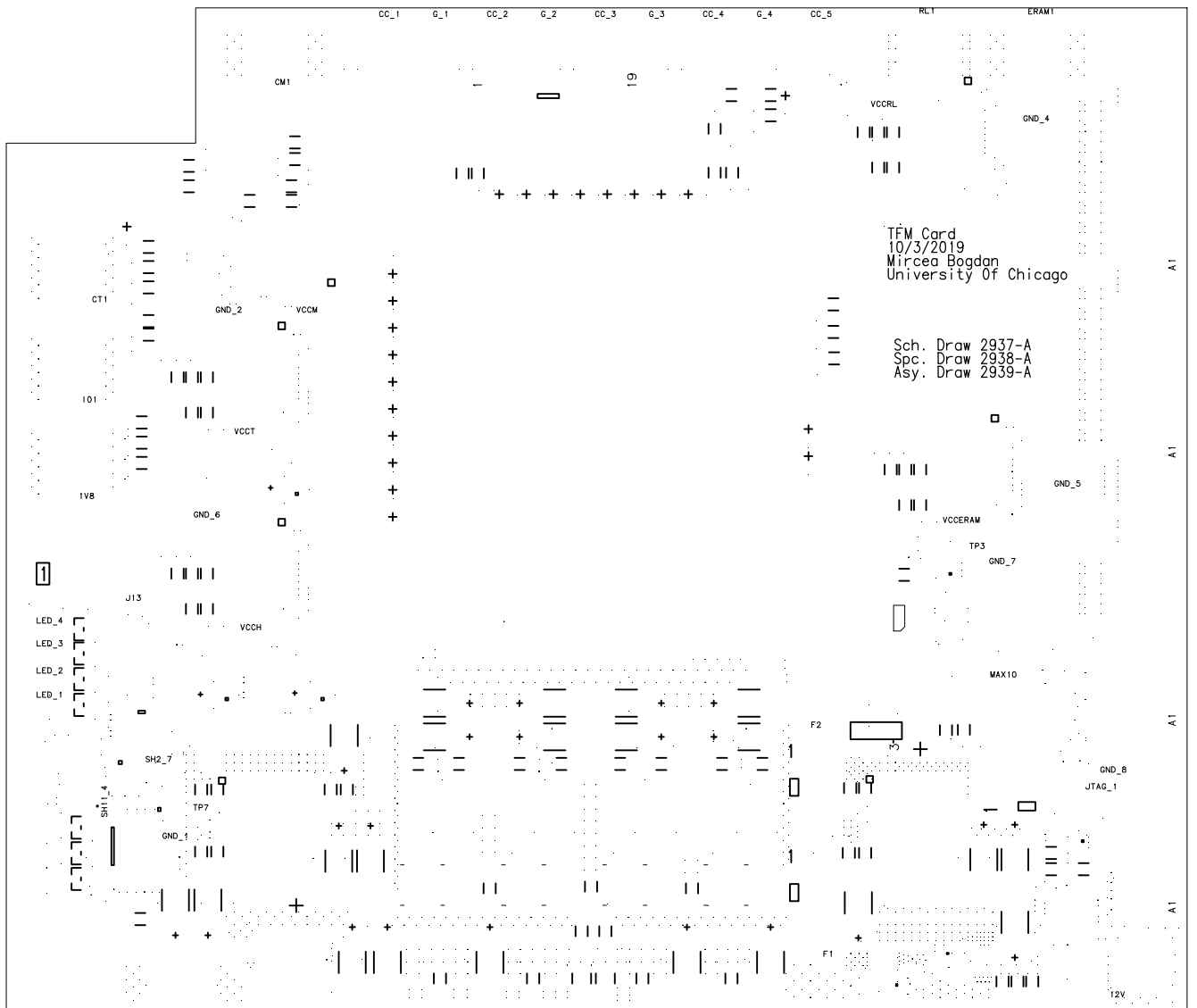

Artwork_18: Bottom Silkscreen

TFM Card
 10/3/2019
 Mircea Bogdan
 Electronics Design Group
 University Of Chicago
 Sch: Draw 2937-A
 Spc: Draw 2938-A
 Asy: Draw 2939-A

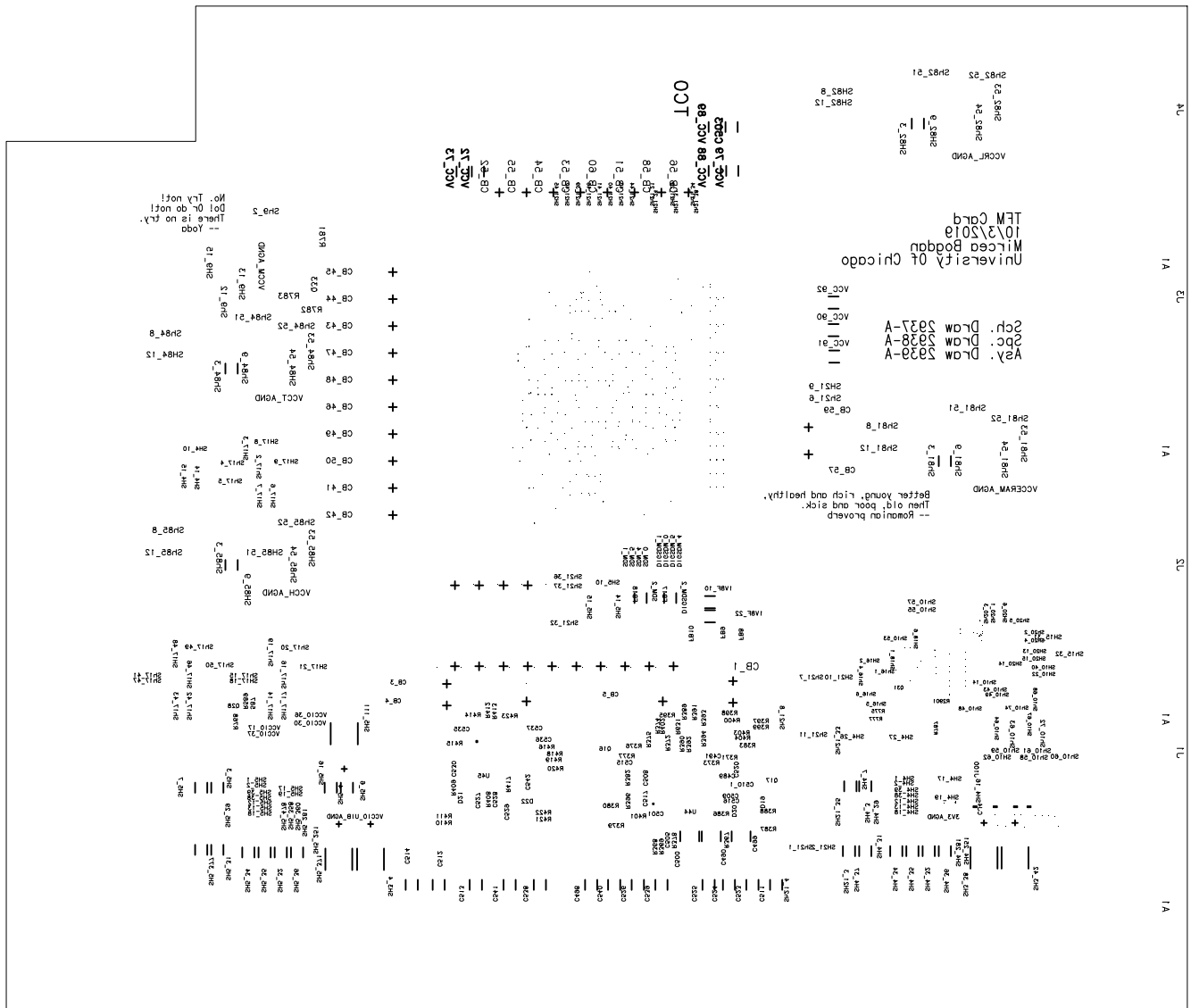

Artwork_19: Top Soldermask

TFM Card
10/3/2019
Mircea Bogdan
Electronics Design Group
University Of Chicago
Sch. Draw 2937-A
Spc. Draw 2938-A
Asy. Draw 2939-A

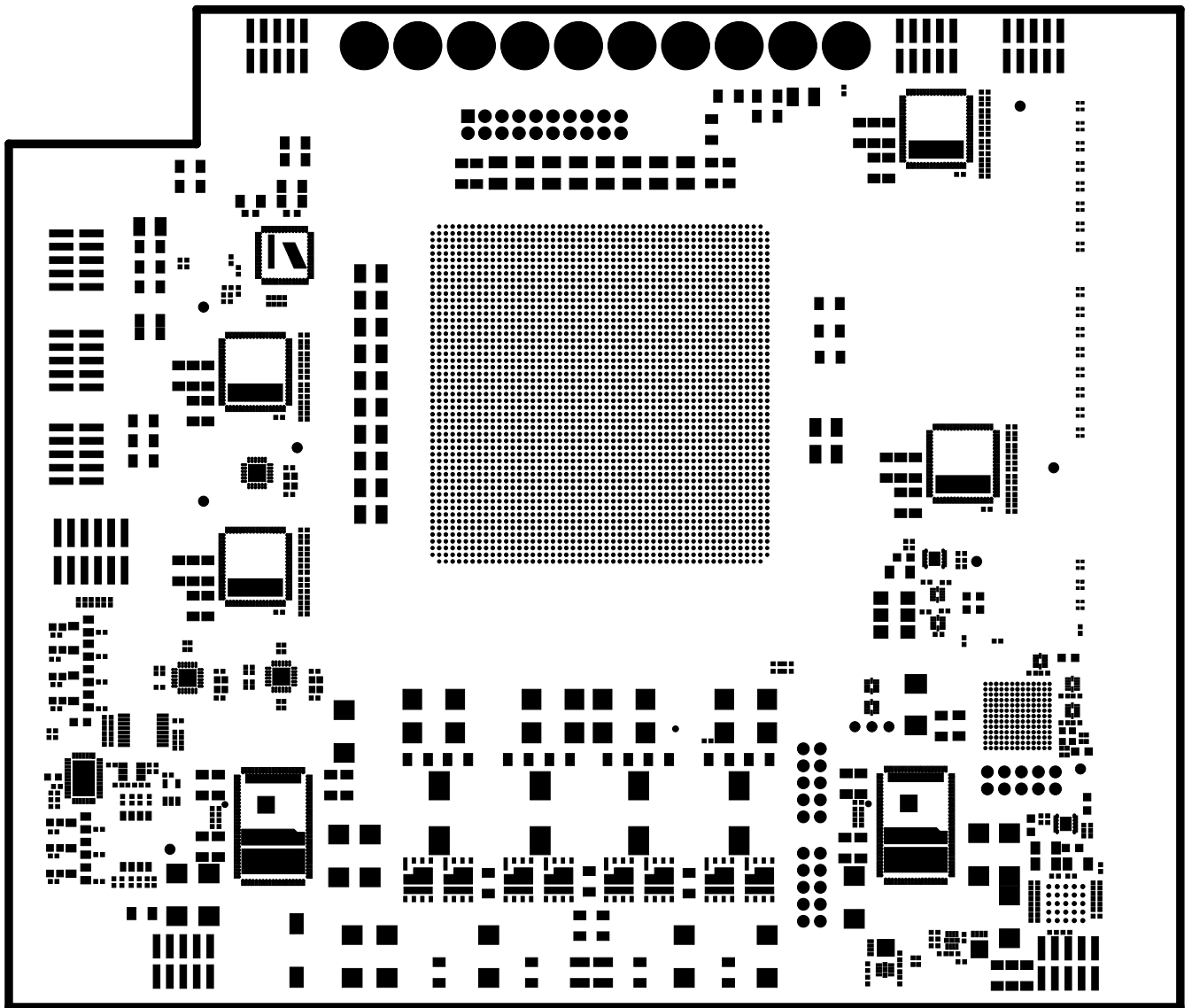

Artwork_20: Bottom Soldermask

TFM Card
10/3/2019
Mircea Bogdan
Electronics Design Group
University Of Chicago
Sch: Draw 2937-A
Spc: Draw 2938-A
Asy: Draw 2939-A

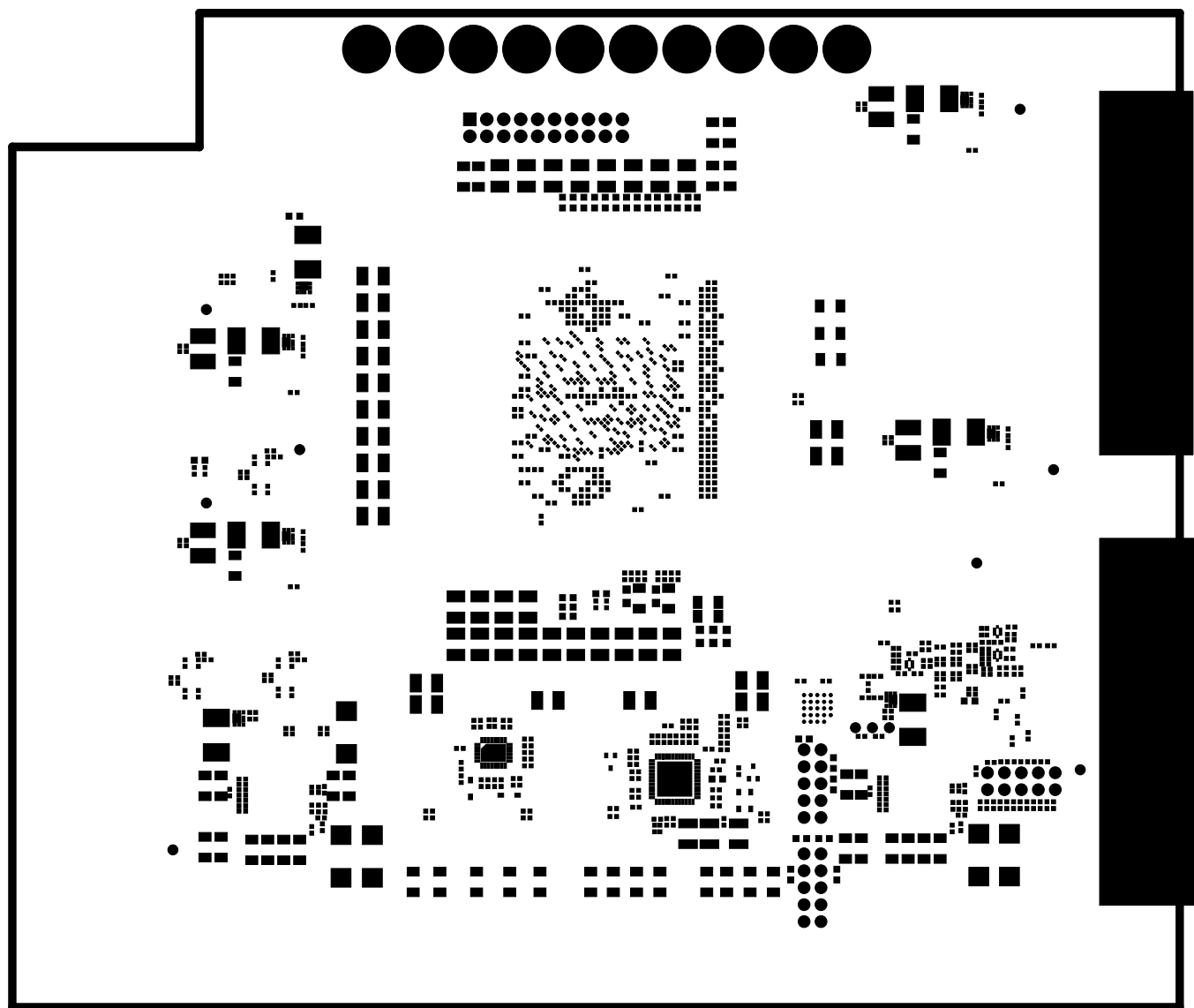

TFM Card
10/3/2019
Mircea Bogdan
Electronics Design Group
University Of Chicago
Sch. Draw 2937-A
Spc. Draw 2938-A
Asy. Draw 2939-A

Artwork_21: Top Pastemask

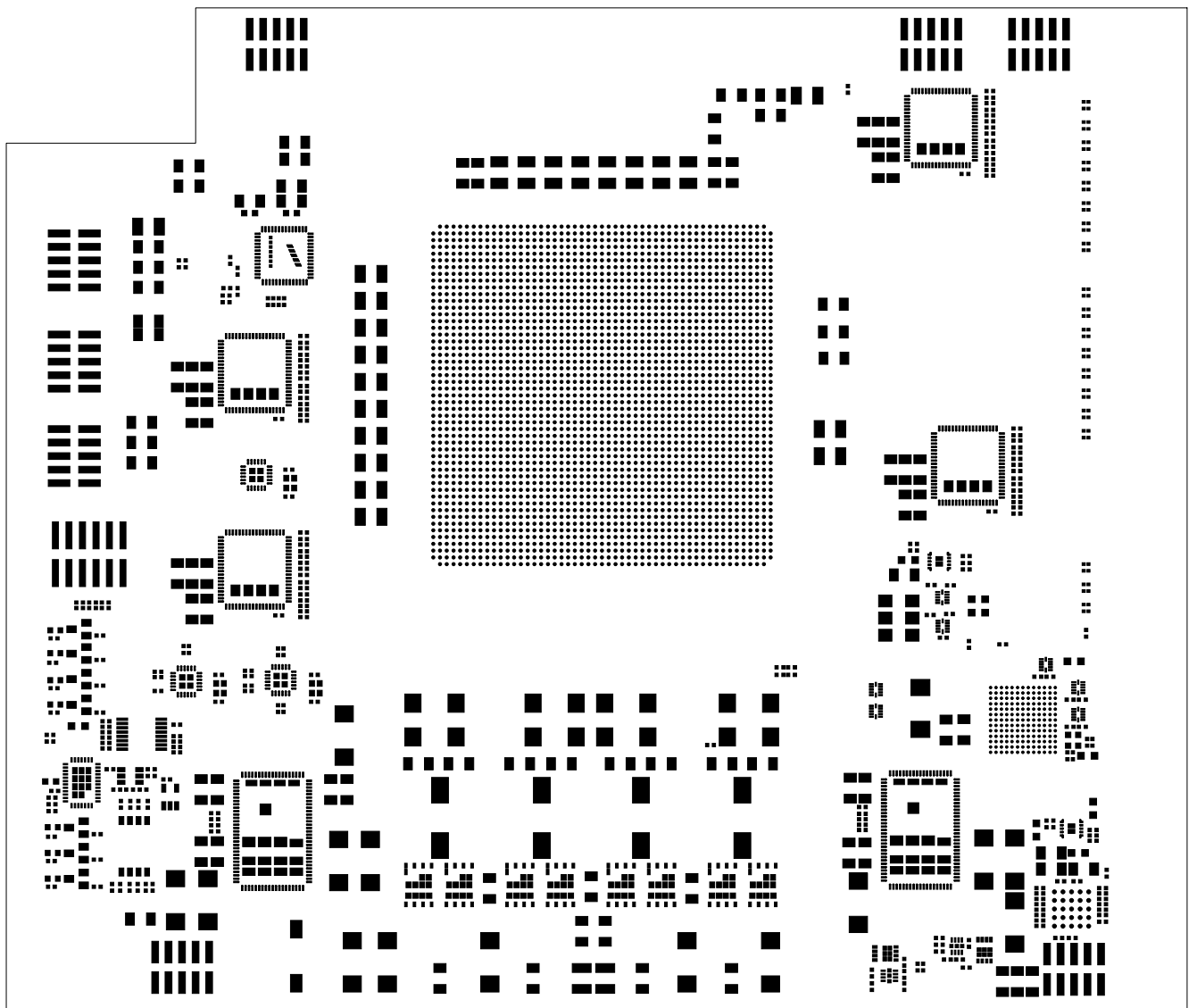

TFM Card
10/3/2019
Mircea Bogdan
Electronics Design Group
University Of Chicago
Sch: Draw 2937-A
Spc: Draw 2938-A
Asy: Draw 2939-A

Artwork_22: Bot Pastemask

