

SCH# B-2526  
 SPC# B-2527  
 ASM# B-2528

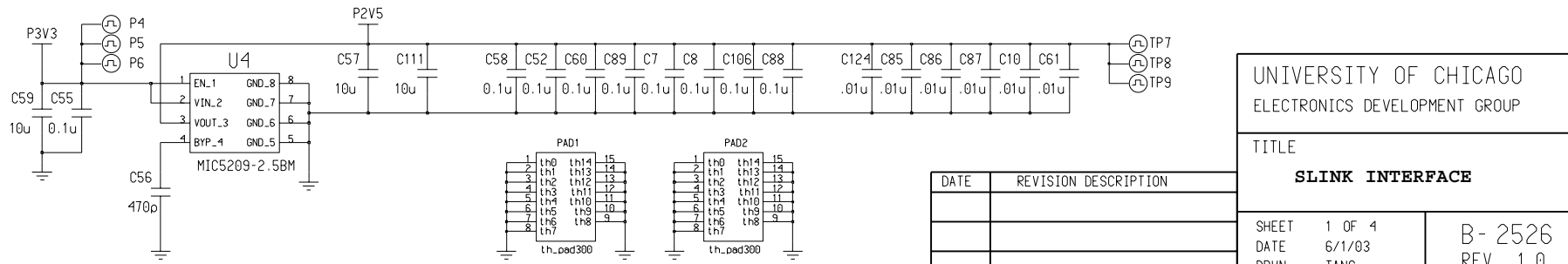
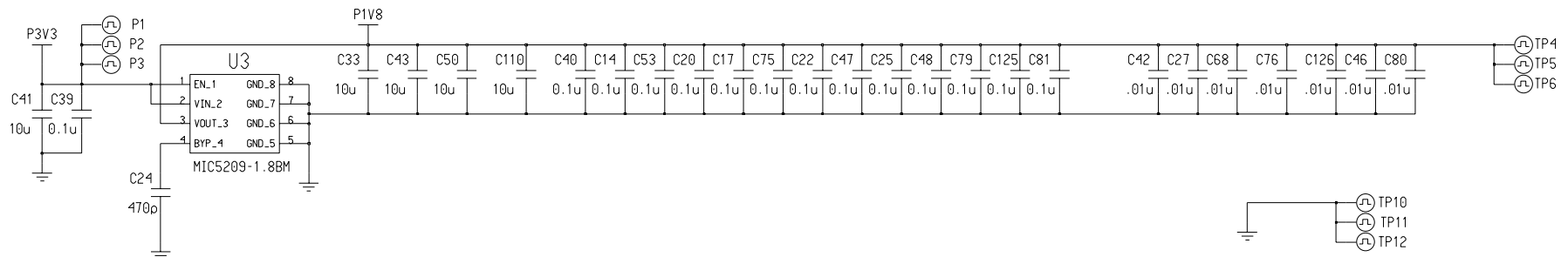
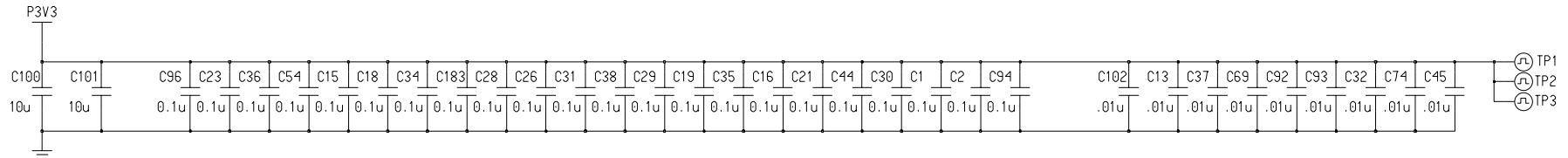
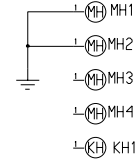
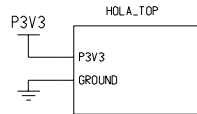

UNIVERSITY OF CHICAGO  
 ELECTRONICS DEVELOPMENT GROUP

TITLE  
**SLINK INTERFACE**

DATE	REVISION	DESCRIPTION

SHEET 1 OF 4	B-2526
DATE 6/1/03	REV 1.0
DRWN TANG	

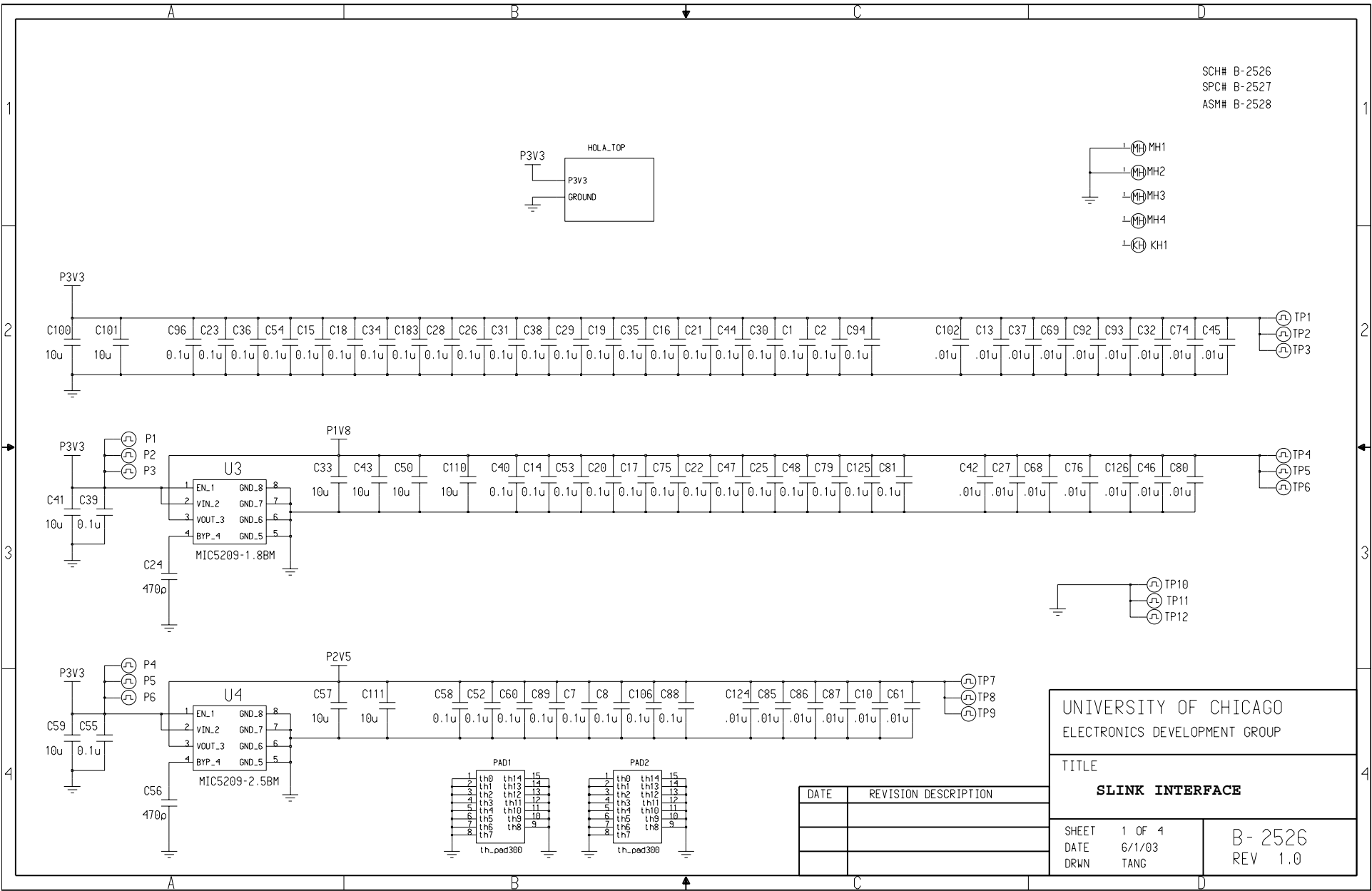

DATA0	EPC_DATA
DCLK	EPC_DCLK
CONF_DONE	EPC_nCS
nSTATUS	EPC_OE
nCONFIG	EPC_nINIT_CONFIG

Don't stuff R10, R11

Don't stuff R10, R11

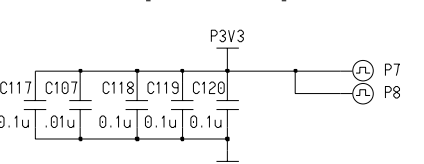
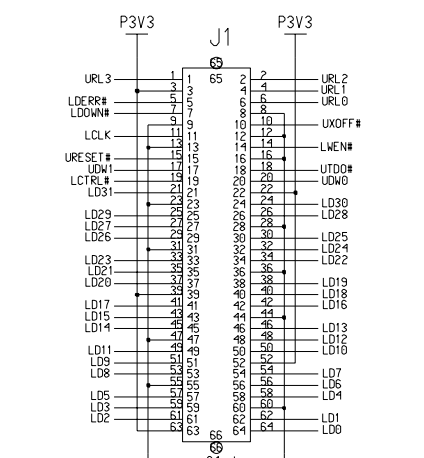
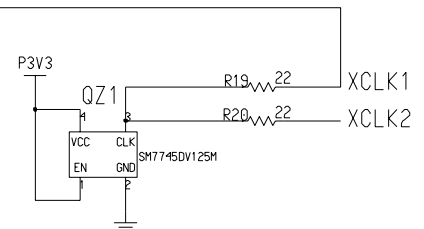
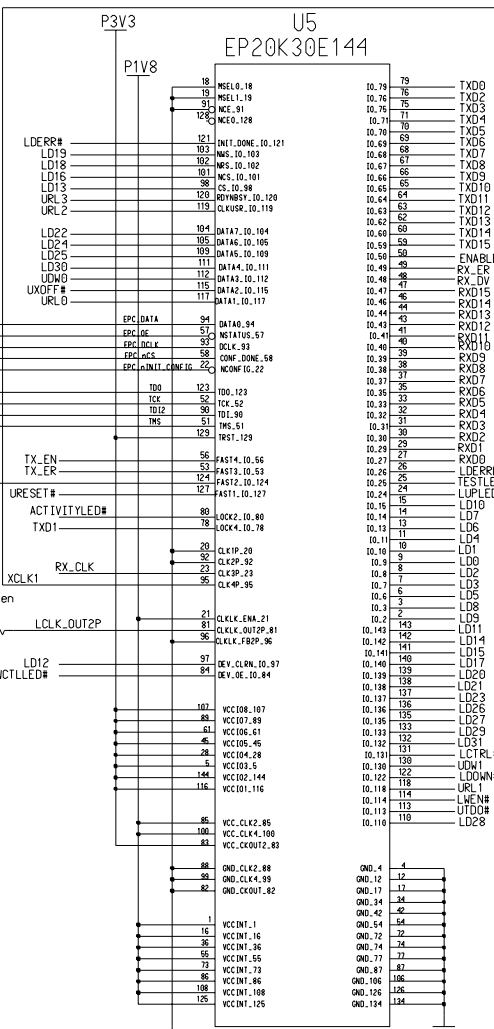
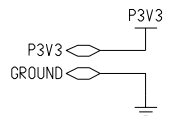
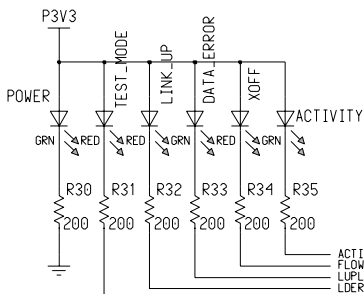
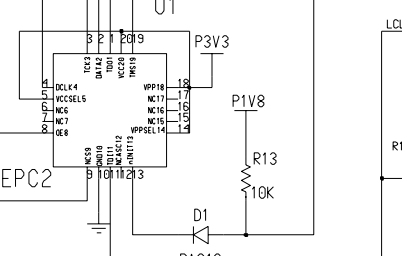
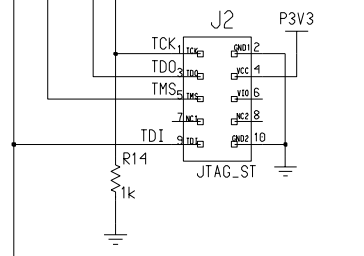
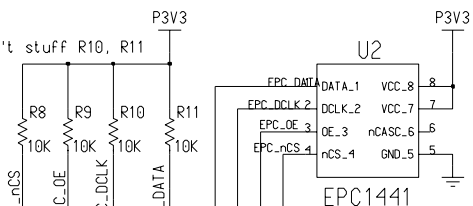
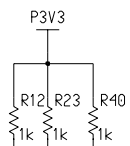

DATE	REVISION	DESCRIPTION

UNIVERSITY OF CHICAGO  
ELECTRONICS DEVELOPMENT GROUP

TITLE  
**SLINK INTERFACE**

SHEET	2 OF 4	B- 2526 REV 1.0
DATE	1/6/03	
DRWN	TANG	

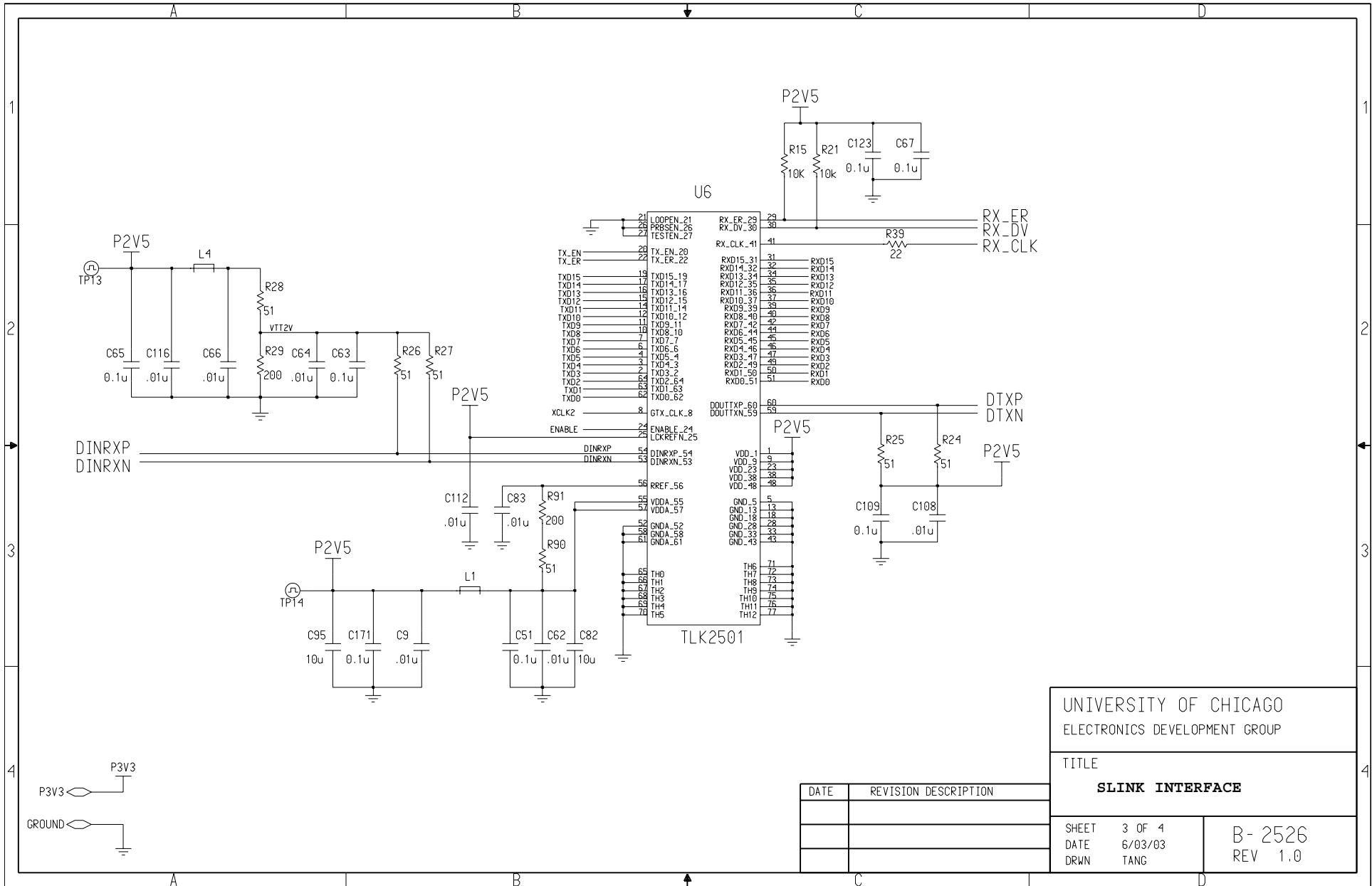

UNIVERSITY OF CHICAGO  
ELECTRONICS DEVELOPMENT GROUP

TITLE  
**SLINK INTERFACE**

DATE	REVISION DESCRIPTION

SHEET	3 OF 4	B-2526 REV 1.0
DATE	6/03/03	
DRWN	TANG	

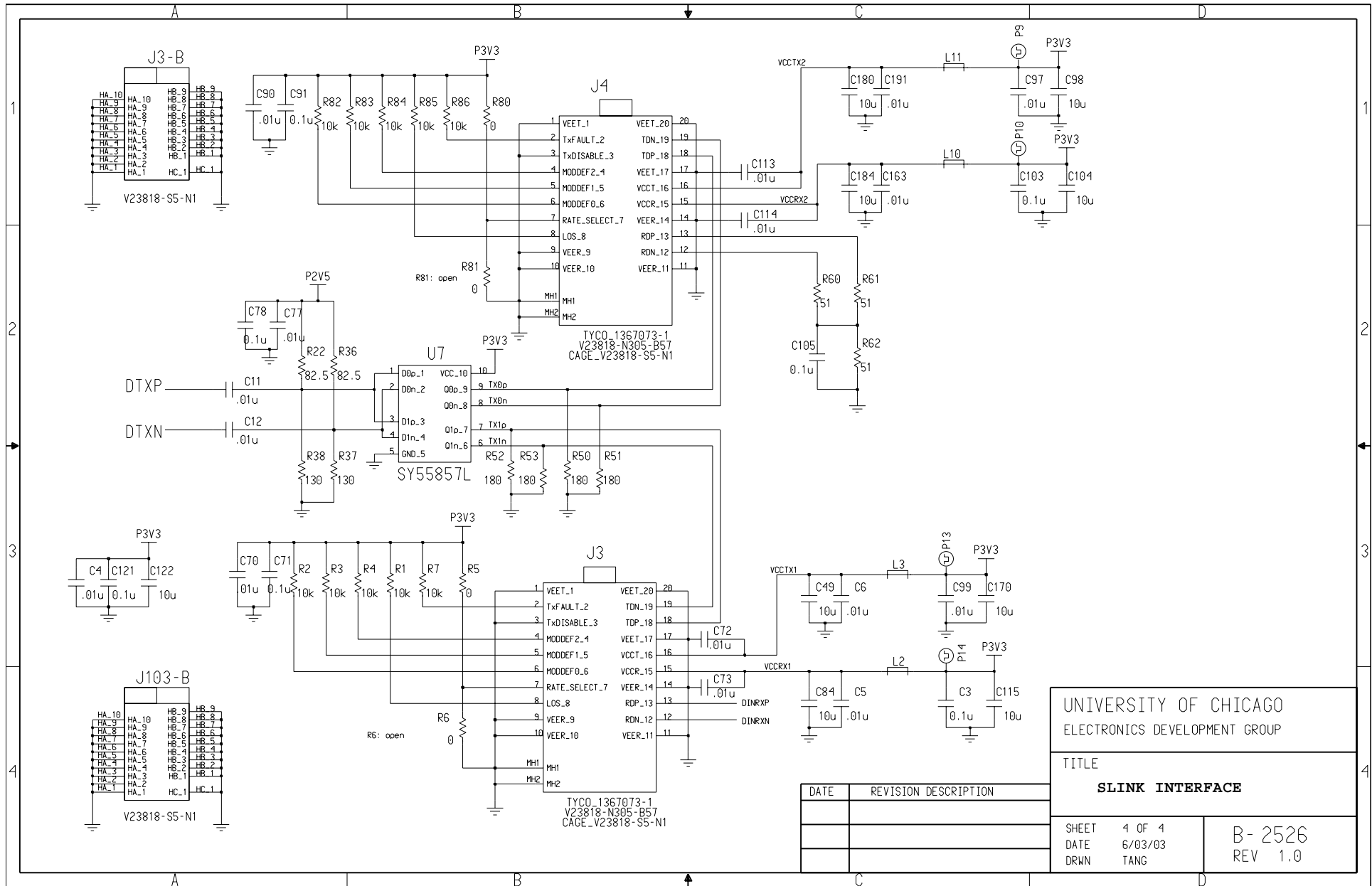

UNIVERSITY OF CHICAGO ELECTRONICS DEVELOPMENT GROUP	
TITLE <b>SLINK INTERFACE</b>	
SHEET 4 OF 4	B-2526
DATE 6/03/03	REV 1.0
DRWN TANG	

DATE	REVISION DESCRIPTION